

EASY-LASER[®]

www.easylaser.com

XT440

Download on the
App Store

GET IT ON
Google Play

RUN IT ON
EASY-LASER XT11



IP66
IP67

Shaft Alignment

XT440

MEASUREMENT INDEPENDENCE



EASY-LASER® GENERATION XT

Easy-Laser® XT440 is the first member of our Generation XT alignment systems, built upon our cross-platform technology. You can now display the data on a multitude of different handheld devices, giving you the freedom to work with the gear that suits you the best. Simply download our straightforward XT application for free and you have all the measurement programs you need.

NO LOCK-INS

With Generation XT you decide if you want the rugged and user-friendly Easy-Laser® XT11 display unit to be included or not. The app also runs on your iOS® or Android® device*, be it a tablet or a phone, meaning you are never locked in to a specific way of working.

NO LICENSE HASSLE

With Generation XT the measuring units run the show! What they can do, the XT Alignment app will allow you to do too. No hassle with licenses to unlock new features in the app. If you have the hardware, you can use all of its capacity. That is straightforward!

**Conditions apply*

MAXIMUM FLEXIBILITY!

The XT Alignment app runs on iOS and Android devices, as well as on the Easy-Laser® XT11 display unit. The choice is yours.*

XT440

HIGHLIGHTS

MAXIMUM FLEXIBILITY



ALL XT PROGRAMS IN ONE FREE APP

All XT measurement programs included in one straightforward application available for free.



DISPLAY DATA ON MULTIPLE PLATFORMS

Functionality for iOS, Android and Easy-Laser® XT display units.



NO LOCK-INS

Buy with or without the new user-friendly Easy-Laser® display unit.



MAXIMUM FLEXIBILITY

Combine several measuring units with the display unit of your choice, or use different display units with one set of measuring units. No license hassle!



RUGGED DESIGN

The XT products are rugged, rated both IP66 and IP67 water and dust proof. For superior durability in harsh environments.



LONG OPERATING TIMES

The long operating times of up to 16 hours for the Display unit and 24 hours for the Measuring units means you will now be able to take on and finish the toughest jobs.

POWERFUL OPTIONS



THERMAL CAMERA

The Easy-Laser® XT11 Display unit has the option to add a thermal imaging camera (IR) along with the standard 13 MP digital camera. Shoot a thermal image before and after alignment and include with the documentation!

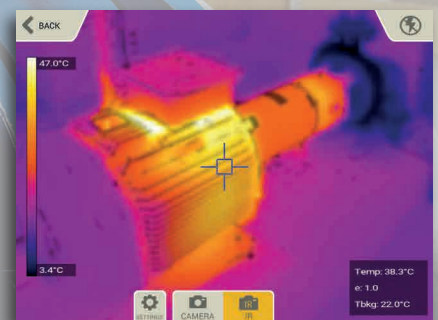

BELT ALIGNMENT

With the Belt alignment tool XT190 BTA* you can align most type of radially mounted drives. You get adjustment values for both horizontal and vertical direction (shim value).

*Accessory

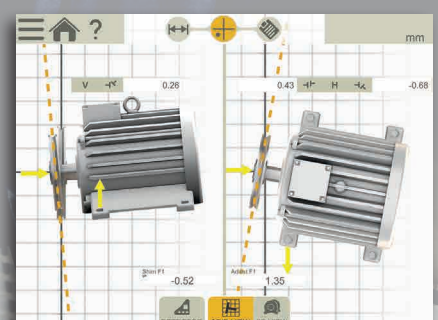

THIS IS EASY ALIGNMENT

HORIZONTAL PROGRAM

 The user interface is intuitive and guides you through the measurement process. It is animated and zooms in to the relevant element for each step. You can save the measurements of a machine for *As found* and *As left* in the same file.

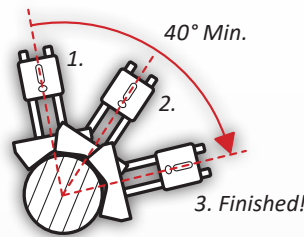

The EasyTurn™ function allows you to begin the measurement process from anywhere on the turn. You can turn the shaft to any three positions with as little as 20° between each position to register the measurement values. Voila! Measurement is complete!

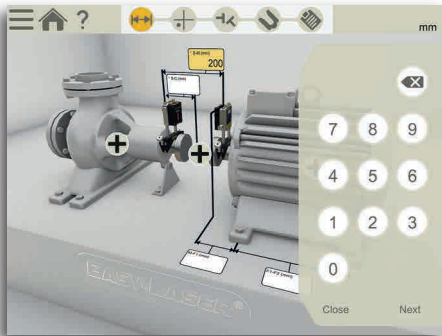

1. Enter dimensions

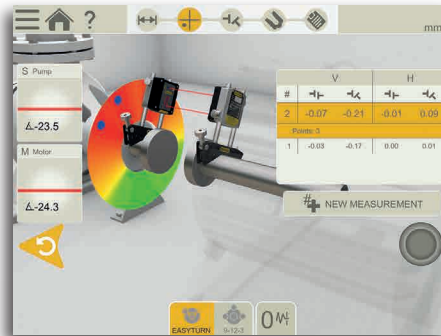

2. Measure (free positions or 9-12-3 o'clock)

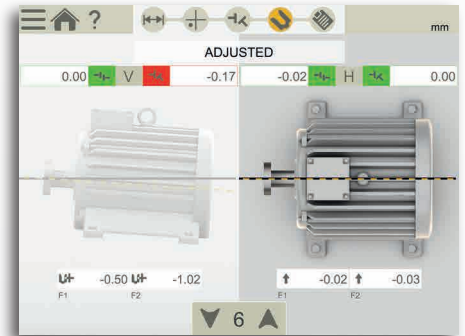

3. View result, As found
4. Adjust

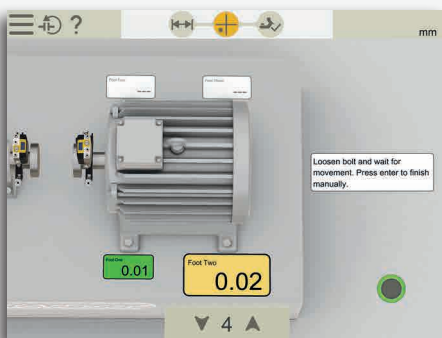

Soft Foot check



Tolerance check (pre-set or custom)

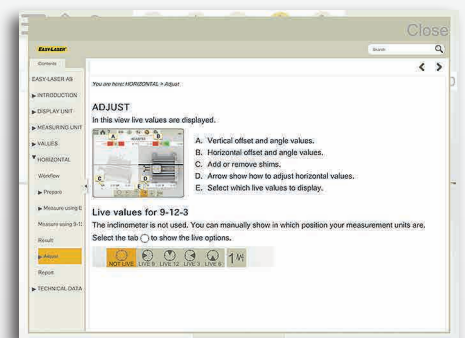

Easy-to-access built-in manual

VALUES – DIGITAL DIAL INDICATOR

 With the Values program you measure as with dial gauges, but with laser precision and the possibility to document the measurement result. You can also use it to check bearing play or shaft load.

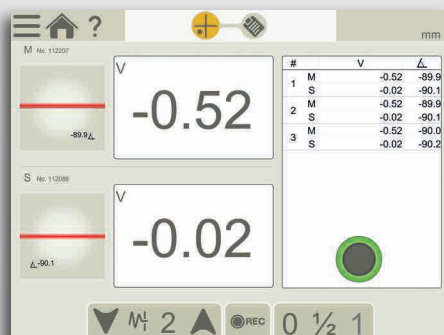

Values from measuring units

VERTICAL/FLANGE MOUNTED MACHINES

 For measurement and alignment of vertically and flange mounted machines. Handles machines with 4, 6, 8 and 10 bolts.

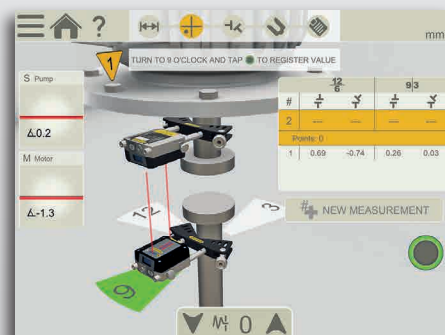

Program for vertically or flange mounted machines

DOCUMENTATION

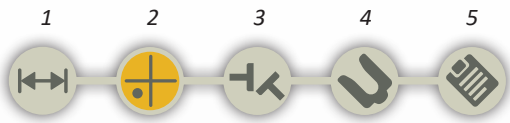

The interactive workflow indicator lets you easily jump to any part in the measurement process.



5. View report as it will look



BUILT-IN HELP

The app includes a searchable *Users Manual* which opens the relevant chapter depending where in the process you are. This makes it quick and easy to find the answer to your user questions.



SELECT MACHINE IMAGE

Choose from different 3D machines to portray your machinery.



SELECT COUPLING TYPE

Choose method depending on coupling type: short flex, spacer shaft.



THERMAL GROWTH

Automatically compensate for thermal expansion of the machines.



SWAP VIEW

Understand adjustment directions more intuitively.



CONTINUE SESSION

Your latest measurement is always available, automatically saved.



MEASUREMENT VALUE FILTER

Improve readings when measuring conditions are poor.



MULTIPLE SETS OF FEET

Align machines with more than two pairs of feet.



LOCKED FEET

Used when aligning base-bound or bolt-bound machines.

SAVE!



INTERNAL MEMORY

Save your measurement files, photos and reports to the internal memory.



VERSATILE FILE TYPES

Both a PDF and an Excel file are generated.

TYPE	NAME	DATE	Edt
Shaft	Shaft_2018-02-14 14_21_05	2018-02-14	
Values	Values_2018-04-10	2018-04-10	
IMG	IMG_20180410_142801	2018-04-10	
Shaft Alignment	Shaft Alignment Water pump 3	2018-04-10	
Vertical motor	Vertical motor ABB	2018-04-14	

EXPLAIN!



PDF REPORT TEMPLATES

Use one of the two formats included, or design your own.



ADD NOTES

Explain it a little more.



ADD PHOTO

Show what you mean.



ADD THERMAL IMAGE

See the difference after alignment. (Available only with XT11)

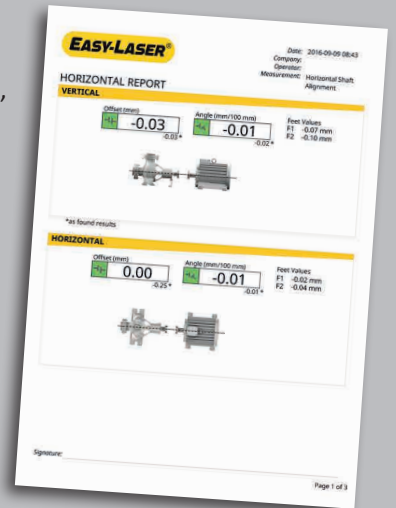

SHARE!



SEND THE REPORTS

Share the reports via email. Possible on all platforms.



SAVE TO USB

Save your files to USB and copy to other devices.



XT440

SYSTEM PARTS

XT40-M/S MEASURING UNITS

The XT40 measuring units have a large 30 mm PSD, and a state-of-the-art OLED display (F) which shows the angle of the unit, making it easier to position it on the shaft. The line laser technology provides a fast setup and easy measurement process. The diagonally positioned locking knobs securely lock the unit on the rods. Rigid aluminium housing provide maximum stability. IP66 and 67, dust- water- and shockproof. Heavy-duty battery for very long operating times; up to 24 hours. Built-in Bluetooth wireless technology.

SHAFT BRACKET

The V-bracket is both light yet rigid, with two rods for maximum stability in all directions. Pre-mounted chain for quick setup on the machine.



- A. Chain tightening knob
- B. Laser angle adjustment (only on M unit)
- C. Charger connector
- D. Laser aperture
- E. PSD aperture
- F. OLED display: battery status/unit angle
- G. Extendable stainless steel rods
- H. Locking knob

XT11 DISPLAY UNIT

Rugged, robust, with wear resistant rubberized protective coating. IP66 and 67, dust- water- and shockproof. As standard a 13 MP camera for documentation is built-in, and you can also choose to add an IR camera to the XT11; shoot a thermal image before and after alignment and include with the documentation!

A large 8", glove-enabled touch-screen makes the information clear and the app easy to use. The small OLED display (C) shows battery status of both measuring units and display unit. You can check battery status also when the unit is turned off (B).

The clever lock-screen button (B) prevents unintentional clicks, for instance when moving around on the job.

Four fastening points for shoulder strap or customized solutions. Heavy-duty battery for very long operating times; up to 16 hours. The camera can be removed if security reasons require it.



- A. Ergonomically, rubber coated housing
- B. Screen-lock button/Battery status-check button
- C. OLED display
- D. Display brightness sensor
- E. Large and clear 8" glove-enabled touch-screen
- F. Dust cover and protection for connectors (Note: connectors are dust and waterproof)
- G. Enter button



TECHNICAL DATA

ACCESSORY BRACKETS

Optional brackets for shaft alignment.

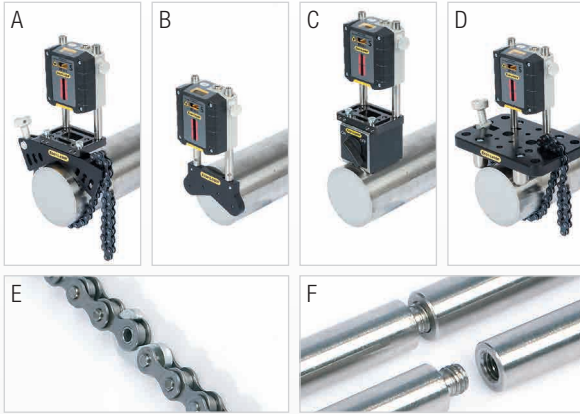

- A. Offset bracket, Part No. 12-1008
- B. Magnetic bracket, Part No. 12-1011
- C. Magnet base, Part No. 12-0013
(Note: offset bracket also needed.)
- D. Sliding bracket, Part No. 12-1010
- E. Extension chain, Part No. 12-1060. Extends the chain for shafts up to diameter 450 mm [17.7"]
- F. Extension rods:
Length 30 mm [1.18"], (x1) Part No. 01-0938
Length 60 mm [2.36"], (x4) Part No. 12-0059
Length 120 mm [4.72"], (x8) Part No. 12-0324
Length 240 mm [9.44"], (x4) Part No. 12-0060

TWO CAMERAS

- A. IR Camera (optional)
- B. 13 Mp Camera
- C. LED Light
- D. Fastening points for shoulder strap (x4)

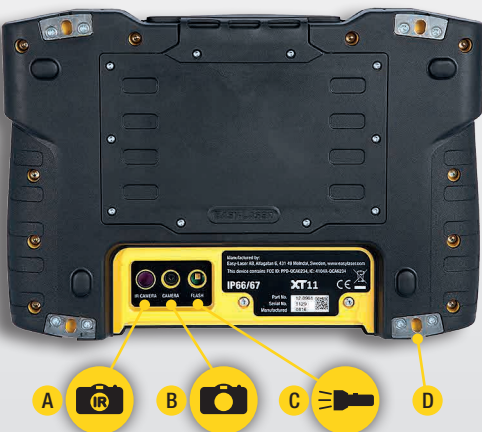

CONNECTORS (DUST AND WATERPROOF)

- E. Charger
- F. USB A
- G. AV connector (HDMI)
- H. USB B



Measuring units XT40-M / XT40-S

Type of detector	TruePSD 30 mm [1.2"]
Communication	BT Wireless technology
Battery type	Heavy duty Li Ion chargeable
Operating time	Up to 24 h continuously
Resolution	0.001 mm [0.05 mils]
Measuring errors	<1%
Measurement range	Up to 10 m [33 feet]
Type of laser	Diode laser
Laser wavelength	635-670 nm
Laser class	Safety class 2
Laser output	<1 mW
Electronic inclinometer	0.1° resolution
Environmental protection	IP class 66 and 67
Operating temperature	-10-50 °C
Storage temperature	-20-50 °C
Relative humidity	10-95%
OLED display	128x64 pixels
Housing material	Anodized aluminium + PC/ABS + TPE
Dimensions	WxHxD: 76x76.7x39.3 mm [3.0x3.0x1.5"]
Weight	245 g [8.6 oz]

Display unit XT11

Type of display/size	SVGA 8" colour screen, backlit LED, multitouch
Battery type	Heavy duty Li Ion chargeable
Operating time	Up to 16 h continuously
Connections	USB A, USB B, Charger, AV
Communication	Wireless technology, WiFi
Camera, with diode lamp	13 Mp
IR camera (optional)	FLIR LEPTON® (0-450 °C, 32-842 °F)
Languages	EN/DE/SE/ES/PT/RU/JP/KO/CHN/IT/FR
Help functions	Built-in manual
Environmental protection	IP class 66 and 67
Operating temperature	-10-50 °C
Storage temperature	-20-50 °C
Relative humidity	10-95%
OLED display	96x96 pixels
Housing material	PC/ABS + TPE
Dimensions	WxHxD: 274x190x44 mm [10.8x7.5x1.7"]
Weight	1450 g [51.1 oz]

Cable

Charging cable (splitter cable)	Length 1 m [39.4"]
---------------------------------	--------------------

Brackets etc.

Shaft brackets	Type: V-bracket for chain, width 18 mm [0.7"]. Shaft diameters: 20-150 mm [0.8-6.0"] Material: anodised aluminium
Rods	Length: 120 mm, 60 mm [4.72", 2.36"] (extendable) Material: Stainless steel



IP66 AND IP67 APPROVED

Easy-Laser® XT is waterproof, dustproof and shock-proof. The units have been tested and approved to an Ingress Protection rating of IP66 and IP67, which means that they are dustproof and waterproof to a depth of 1 metre, and also protected against powerful water jets.

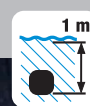

CHOOSE YOUR SYSTEM!



XT440

System Easy-Laser® XT440 Shaft, Part No. 12-0966, includes:

- 1 Measuring unit XT40-M
- 1 Measuring unit XT40-S
- 2 Shaft brackets with chains and rods
- 4 Rods 60 mm [2.36"]
- 1 Measuring tape 3 m [9.8']
- 1 Hexagon wrench set
- 1 Charger (100–240 V AC)
- 1 DC split cable for charging
- 1 DC to USB adapter, for charging
- 1 Quick reference manual
- 1 Cleaning cloth for optics
- 1 USB memory with manuals

1 Carrying case Small
 Weight: 3.8 kg [8.4 lbs]
 Dimension WxHxD: 335x280x130 mm [13.2"x11.0"x5.1"]



XT440 WITH DISPLAY UNIT

System Easy-Laser® XT440 Shaft with Display unit XT11, Part No. 12-0967 includes:

- 1 Display unit XT11
- 1 Measuring unit XT40-M
- 1 Measuring unit XT40-S
- 2 Shaft brackets with chains and rods
- 4 Rods 60 mm [2.36"]
- 1 Measuring tape 3 m [9.8']
- 1 Hexagon wrench set
- 1 Charger (100–240 V AC)
- 1 DC split cable for charging
- 1 DC to USB adapter, for charging
- 1 Shoulder strap for display unit
- 1 Quick reference manual
- 1 Cleaning cloth for optics
- 1 USB memory with manuals
- 1 Documentation folder

1 Carrying case Medium
 Weight: 7.2 kg [15.9 lbs]
 Dimension WxHxD: 460x350x175 mm [18.1"x13.8"x6.9"]

Easy-Laser® XT Alignment App



Customize your XT11 (Note that these options cannot be retrofitted):

- Part No. 12-0968 IR Camera added to XT11
- Part No. 12-0985 Camera (and LED light) removed from XT11



IR Camera added



Camera removed

Easy-Laser® is manufactured by Easy-Laser AB, Alfagatan 6, SE-431 49 Mölndal, Sweden
 Tel +46 31 708 63 00, Fax +46 31 708 63 50, e-mail: info@easylaser.com, www.easylaser.com
 © 2018 Easy-Laser AB. We reserve the right to make changes without prior notification.
 Easy-Laser® is a registered trademark of Easy-Laser AB. Android, Google Play, and the Google Play logo are trademarks of Google Inc. Apple, the Apple logo, iPhone, and iPod touch are trademarks of Apple Inc., registered in the U.S. and other countries. App Store is a service mark of Apple Inc. Other trademarks belong to their respective owners. This product complies with: EN60825-1, 21 CFR 1040.10 and 1040.11. Contains FCC ID: Q0QBGM111, IC: 5123A-BGM111 and FCC ID: PPD-QCA6234, IC: 4104A-QCA6234. Documentation ID: 05-0830 Rev5

