

proceq

Proceq DY-2 Operating Instructions



Swiss Precision since 1954

Table of Contents

1.	Safety and Liability	2
1.1	Safety and Usage Precautions	2
1.2	Liability	2
1.3	Safety Instructions	2
1.4	Compliance with Standards	2
2.	Standards and Equipment Selection.....	3
2.1	Summary of the main pull-off testing standards.....	3
2.2	Proceq DY-2 Models.....	4
3.	Getting started	5
3.1	Charging the Proceq DY-2	5
3.2	The Proceq DY-2 Operating Panel	5
3.3	The Proceq DY-2 Menu.....	6
4.	Test Parameter Settings	6
5.	Performing a Pull-Off Test with Proceq DY-2.....	9
5.1	Test Preparation	9
5.2	Measurement Procedure.....	10
5.2.1	Peak load, test duration and effective load rate	11
5.2.2	Load rate warning	11
5.3	Failure Mode Recording	12
5.4	Emergency Stop	12
6.	Accessories.....	13
6.1	Working with large test discs	13
6.2	Working on vertical surfaces or overhead.....	13
7.	Ordering Information	14
7.1	Units	14
7.2	Test Discs and Accessories	14
8.	Technical Specifications.....	15
8.1	Maintenance and Support.....	15
8.2	Standard Warranty and Extended Warranty	15
9.	DY-Link Software	16

1. Safety and Liability

1.1 Safety and Usage Precautions

This manual contains important information on the safety, use and maintenance of the Proceq DY-2. Read through the manual carefully before the first use of the instrument. Keep the manual in a safe place for future reference.

1.2 Liability

Our “General Terms and Conditions of Sale and Delivery” apply in all cases. Warranty and liability claims arising from personal injury and damage to property cannot be upheld if they are due to one or more of the following causes:

- Failure to use the instrument in accordance with its designated use as described in this manual.
- Incorrect performance check for operation and maintenance of the instrument and its components.
- Failure to adhere to the sections of the manual dealing with the performance check, operation and maintenance of the instrument and its components.
- Unauthorized structural modifications to the instrument and its components.
- Serious damage resulting from the effects of foreign bodies, accidents, vandalism and force majeure.

All information contained in this documentation is presented in good faith and believed to be correct. Proceq SA makes no warranties and excludes all liability as to the completeness and/or accuracy of the information.

1.3 Safety Instructions

The instrument is not allowed to be operated by children or anyone under the influence of alcohol, drugs or pharmaceutical preparations. Anyone who is not familiar with this manual must be supervised when using the instrument.

1.4 Compliance with Standards

Proceq DY-2 complies fully with the standards listed in the next chapter.

Proceq DY-2 is calibrated according to EN ISO 7500-1 Annex C - Alternative Method of Testing Machine Classification.

The software necessary to calibrate the instrument is included in DY-Link.

2. Standards and Equipment Selection

2.1 Summary of the main pull-off testing standards

Standard	Description	Test disc	Specified load rate	Total test time
EN 1542	Products and systems for the protection and repair of concrete structures - Measurement of bond strength by pull-off	Ø 50mm	0.05 ± 0.01 Mpa/s	< 90s
EN 1015-12	Determination of adhesive strength of hardened rendering and plastering mortars on substrates	Ø 50mm	0.003 – 0.1 MPa/s	20-60s
EN 1348	Mortar for tiles and slabs. Determination of the adhesive strength of cement based mortar for indoor and outdoor.	Ø 50mm	250 ± 50 N/s	-
ISO 4624	Paints and varnishes - Pull-off test for adhesion. Supersedes EN24624 and NF T30-062	Ø 20mm	< 1 MPa/s	< 90s
BS 1881 Part 207	Recommendations for the assessment of concrete strength by near-to surface tests	Ø 50mm	0.05 ± 0.03 MPa/s	-
ASTM D 4541	Standard test method for pull-off strength of coatings using portable adhesion testers	-	< 1 MPa/s	< 100s
ASTM C 1583	Standard test method for tensile strength of concrete surfaces and the bond strength or tensile strength of concrete repair and overlay materials by direct tension (Pull-off method)	Steel Ø 50mm	5±2 psi/s 0.035±.015MPa/s	-
ASTM D 7234-05	Standard test method for pull-off adhesion strength of coatings on concrete using portable pull-off adhesion testers	Ø 20mm Ø 50mm Ø 75mm	< 0.2MPa/s, 30psi/s	5s to 30s
ASTM D 7522	Standard test method for pull-off strength of FRP bonded to concrete substrate	Ø 50mm Ø 75mm Ø100mm	< 1 MPa/min < 150 psi/min	
ZTV-ING	The Federal Minister for Transport. Additional technical contract conditions and guidelines for engineering buildings and the repair of concrete components	Ø 50mm	100 N/s for concrete 300N/s for elastic surfaces (Proceq DY-206, Proceq DY-216 recommended for elastic surfaces)	

Standard	Description	Test disc	Specified load rate	Total test time
SIA 281/3	Bitumen sheeting pull-off testing	dia. 50mm 300 +/- 15 N/s	(Proceq DY-206, Proceq DY-216 recommended for elastic surfaces)	
JGJ110	Construction Engineering decorative tile Adhesive Strength Testing Standard			
JGJ126	The Exterior Decorative Brick Construction and Inspection Acceptance Standard	95x45x8mm, 40x40x8mm		
JGJ144	Exterior Insulation Engineering Technical Standard	100x100x8mm		

2.2 Proceq DY-2 Models

Three versions of Proceq DY-2 are available differentiated by maximum pulling force.

- Proceq DY-206 has increased accuracy for low strength applications. Recommended for elastic surfaces due to higher requirement on load rate.
- Proceq DY-216 covering most applications. Recommended for elastic surfaces due to higher requirement on load rate.
- Proceq DY-225 required for compliance with ASTM C 1583. Typically used for testing of fibre reinforced polymers bonded to concrete structures.

The table below shows the recommended working range with a selection of test discs to help you ascertain which model is most suited to your application.

	Working Range		Maximum Pulling Speed
	Tensile Force	Test Disc Ø 50mm	
Proceq DY-206	0.6 - 6 kN	0.3 - 3.1 MPa	4.65 mm/min 0.183 inch/min
	135 - 1349 lbf	44 - 443 psi	
Proceq DY-216	1.6 - 16 kN	0.81 - 8.1 MPa	2.2 mm/min 0.086 inch/min
	360 - 3597 lbf	118 - 1182 psi	
Proceq DY-225	2.5 - 25 kN	1.3 - 12.7 MPa	
	562 - 5620 lbf	185 - 1847 psi	



Note: The instrument begins to display and record measurement values from 0 kN.

3. Getting started



Note: When shipped, battery packs are not fully charged. Prior to use, please charge the battery completely. To prevent the battery from damage, avoid deep-discharging or storing it long-term when empty. Store the instrument at room temperature and charge the battery fully at least once a year.

3.1 Charging the Proceq DY-2

A fully charged battery is sufficient for approximately 80 complete load cycles. The battery status symbol will be displayed when the accumulator is at 10% of its capacity. In this case it is still possible to make measurements, but it is advisable to recharge the battery by connecting the unit to a wall adaptor or a PC via the mini-USB port on the rear of the instrument. A complete charging cycle will take approximately 3 hours (longer in the case of a deep-discharge).



Note: When charging the battery or when operating on mains supply, the charging circuit will be disconnected after 5 hours of continuous charging. This is a safety precaution. The instrument will then turn off after a further 5 minutes.

A reserve battery pack (Part No. 346 10 220) may be purchased and held in reserve.

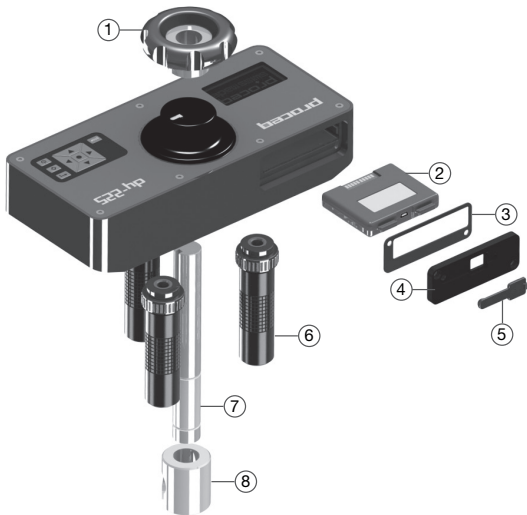

- 1 Hand wheel
- 2 Battery pack complete
- 3 Seal for battery compartment
- 4 Cover plate for battery compartment
- 5 USB cover
- 6 Foot complete
- 7 Draw spindle
- 8 Coupling for the draw bolt

3.2 The Proceq DY-2 Operating Panel

Use the navigation keys to highlight a menu item and press the center key to select it.



Back button – Returns to the previous menu without making any changes

2nd Function button – Access a 2nd function screen

Power button

The STOP button is used to stop the test at any time. See 5.4.

Operation - Power ON / OFF

- Power ON - Press the power button.
- Power OFF - It is only possible to power off from the main menu screen. If you are in any other menu, press the back button to return to the main menu.

Press the power button once for the information screen showing the serial number, hardware and firmware versions and the battery status:









Press the power button again to power off.

- Return to the main menu from the information screen by pressing the center key or the back button.

The instrument shuts down automatically after 5 minutes of inactivity.

3.3 The Proceq DY-2 Menu

On start-up the main menu screen will be shown.

	Set Measurement Unit		Start Test		Memory
	Select Test Disc Diameter / Set Test Disc Area		Set Load Rate / Set Maximum Load		Set Date and Time

4. Test Parameter Settings



Note: The most current test settings are saved when the unit is powered off.

Setting the Units

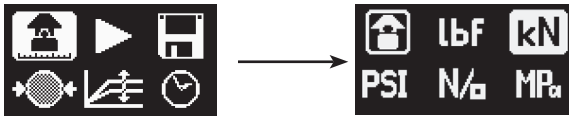

- Choose between: lbf, kN, psi, N/mm² and MPa.
- Press the center key to complete the action.



Note: Once the unit has been selected, the load rate selection will be defined in the same unit. Load rate and disc size settings remain the same when switching from one unit to another. The unit is converted automatically, e.g. 50 mm = 1.97", 0.2 MPa/s = 29 psi/s

Set the Test Disc Size



For circular test discs:

- Enter the diameter of the disc.
- Press the center key to complete the action.

For square discs:

- Press the 2nd function key.
- Enter the surface area, e.g. for a 50x50 mm test plate, the surface area is 2500 mm². (Note the diameter setting will show a theoretically calculated value in this case.)
- Press the center key to complete the action.

Set the Load Parameters



Maximum applied load:

- To set a maximum applied load, press the 2nd function key.
- Enter the maximum load to be applied during the test. The minimum permissible setting for this parameter is 20 % of the maximum value. If no maximum load is required, this should be set at the maximum value supported by the instrument, i.e. 6 kN, 16 kN or 25 kN.
- Press the center key to complete the action.

Load rate:

- Set the load rate specified by the standard. If a load rate is not specified, a typical load rate of 100 N/s (22.5 lbf/s) may be selected.
- Press the center key to complete the action.

End of test criteria:

- To set the criteria for test completion, press the 2nd function key again. The default value is 80 %. This means that the test will be completed when the load has dropped to 80 % of the peak load.
- When testing on softer or elastic materials it is possible that the test disc does not separate completely from the substrate. Setting this parameter to 0 % will ensure that the instrument continues pulling until the maximum stroke of 5mm is achieved.

Set the Date and Time

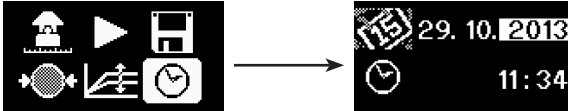

Every measurement is saved with a time stamp.

Set the date and time:

- Use the left and right navigation keys to select the item from either column.
- Use the up and down navigation keys to adjust the value.
- Press the center key to complete the action.

Measurement Memory

Memory can hold a maximum of 100 measurements.

When completely full, the oldest will be overwritten.

To review the saved measurements follow the procedure below:

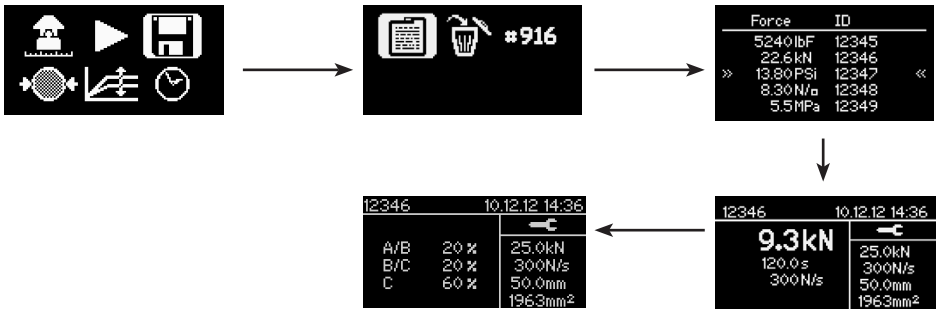

- Choose the memory icon.
- Choose the icon to review the measurements.
- Scroll to the desired measurement and press the center key to see the measurement details.

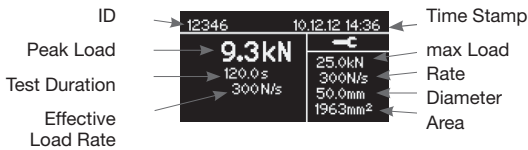

- Press the left and right navigation keys to switch between the main test result (see above) and the failure mode reporting screens (see below).

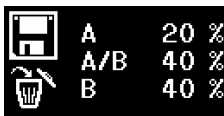

Details see chapter 5.3.

Measurement ID



The measurement ID may be set by the user. The ID is incremented after each measurement.

- Press the center key to complete the action.

Deleting all saved objects



- Press the center key to delete.
- Press the back button to escape without deleting.

5. Performing a Pull-Off Test with Proceq DY-2

Proceq DY-2 is designed to make it very easy to work according to the various standards for pull-off testing. It allows the user to specify a load rate and provides a graphical display (via DY-Link software) of the effective load rate achieved during the test. The standards vary according to the purpose of the pull-off test and the types of material under test. (See the list in Chapter 2). Typically, the key test parameters are:

- The size of the test disc
- The load rate applied to the test disc
- The total time allowed for the test

5.1 Test Preparation

Pull-off testing is used on many different types of materials. The actual test parameters should be taken from the specified standard as noted below.

- Preparation of the test disc. Depending on the material under test, it may be necessary to roughen the surface using emery paper to ensure good adhesion. It is also advisable to remove any grease from the surface.
- Gluing the test disc to the surface under test. The type of adhesive will vary with the application, but typical adhesives used are:
 - Devcon 2 Ton Epoxy
 - Loctite 907, Loctite 3430
 - Sikadur 30, Sikadur 31
 - Araldite Regular/Rapid
- Isolation of the test area by partial coring, or cutting. Typically a coring bit of the appropriate size (e.g. 50mm) is used to drill through the coating and into the concrete substrate. (E.g. EN 1542 recommends 15mm into the substrate).



Core



Test disc

- Waiting for the adhesive to set.
- Fixing the draw bolt to the test disc. (Proceq DY-2 test discs use a 10mm draw bolt. 8mm and 12mm draw bolts are also available).
- Fit the draw bolt to the coupling.

This completes the test preparations.



Note: When measuring on perfectly horizontal or vertical surfaces a spirit level may be used if desired to check the alignment of the pull-off tester. Correct alignment may be achieved by adjusting the screws on the legs. If the surface is inclined, this method is not practical.

5.2 Measurement Procedure



Press the center key to begin.

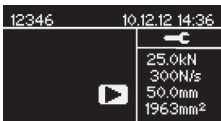

Verify settings. (Note: In the case of square discs, the diameter is a theoretical value.)
Parameters can only be reviewed. To make changes, press back to return to main menu.



Pre-loading. Turn the hand wheel to take up the slack on the test disk until a force (>0) is indicated as a blinking measurement. The force applied is minimal.
Press the center key to start the test.



The measurement screen indicates the increase in load.
A nominal load rate is applied until a force of 250 N (56 lbf) is applied. At this point the programmed load rate is applied for the duration of the test.

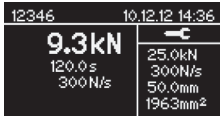

On completion of the test the summary screen shows the peak load, test duration and the effective load rate. The motor winds back automatically ready to begin the next test.

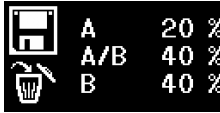

Press the center key to enter “Failure Mode Recording”. (See below.)

Press on save to complete the test and return to the main menu.

If you do not wish to save the test, select the delete icon and press the center key to return to the main menu.



Note: If you do not wish to record the failure mode, simply press on save to complete the test. The test will be saved and you will return to the main menu.

5.2.1 Peak load, test duration and effective load rate

The peak load is the maximum load achieved during the test.

The test duration begins when the load reaches 250 N (56 lbf) (load rate control begins) and ends at the time when the end of test criteria is reached. If this is set to 0 % this can be misleading. Look at the graphical output in this case for confirmation.

The effective load rate is calculated from the point at which load rate control begins (250N) to the time at which 80 % of the peak load is reached. (This is done to avoid inconsistencies in load rates caused by non-clean breaks when elastic and thermoplastic materials are being tested.)

5.2.2 Load rate warning

Pull-off testing from a single side, is best suited for rigid substrates. Deformable substrates or elastic coatings can lead to a falsification of the results of a pull-off test. Proceq DY-2 provides the tools to help in the analysis when testing on such materials.

If the load graph appears on the measurement screen as a blinking icon during a test, it indicates that the programmed load rate cannot be achieved.



The most likely cause of this is due to plastic deformation of either the substrate or the material under test or the selection of a load rate beyond the capabilities of the instrument (see technical specifications).

It is recommended in this case to store the test result and download it to DY-Link for detailed analysis.



5.3 Failure Mode Recording

Many standards also require the user to record the mode of failure in varying degrees of complexity. Proceq DY-2 allows the user to record the failure mode with the test result for comprehensive reporting. The possibility to record the failure is flexible enough to accommodate the requirements of the various standards.

e.g. ISO 4624 failure mode reporting classification.

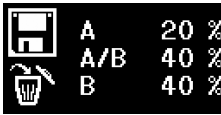
- A is a cohesive failure of the substrate;
- A/B is an adhesive failure between the substrate and the first coat;
- B is a cohesive failure of the first coat;
- B/C is an adhesive failure between the first and second coats;
- etc.
- Estimate the area of fracture as a percentage to the nearest 10% for each type of fracture.



	A	20 %
	A/B	40 %
	B	40 %

The first column indicates where the break took place. The second column indicates the percentage of the break in that particular layer.

For simplified reporting as specified for example in ASTM C 1583, then the user would enter for example B 100% indicating a failure at the first coating.

- Use the navigation keys to select the item from either column.
- Define your own classifications for A, B, etc.
- Use the center key to alter the value.

5.4 Emergency Stop

In case of an emergency the red-colored STOP button can be pressed. The instrument stops in any case and the following dialog appears:



- Selecting the "Rewind" icon lets the instrument move back to its starting position.
- Selecting the "Cancel" icon lets you return to the main menu without any movement of the motor and you may proceed with the test.

6. Accessories

6.1 Working with large test discs

The standard Proceq DY-2 configuration can be used with test discs up to 50mm diameter or 50 x 50mm square.

Adapter plate for large test discs

The adapter plate (Part No. 346 10 530) accommodates all test discs in the Proceq range.



Note: When working with the adapter plate the maximum load must not exceed 16kN. (See Chapter 4 - "Set the Load Parameters").

6.2 Working on vertical surfaces or overhead

When working on vertical surfaces or overhead ensure that the test disc is firmly glued to the surface before coupling the Proceq DY-2. When the test is completed the instrument will fall unless properly supported either by hand or by a mechanical fixing.

An optional fixing kit is available for this purpose (Part No. 346 10 550).



Warning! The operator is responsible for making sure that the instrument cannot fall and cause damage or injury.

7. Ordering Information

7.1 Units

Part No.	Description
346 10 000	Proceq DY-206 Pull-off tester 6 kN (1349 lbf) including: battery pack, battery charger with USB-cable, test disc aluminium Ø 50mm/M10, draw bolt M10, torx screwdriver, software, operating instructions, calibration certificate and carrying case
346 20 000	Proceq DY-216 Pull-off tester 16 kN (3597 lbf) including: battery pack, battery charger with USB-cable, test disc aluminium Ø 50mm/M10, draw bolt M10, torx screwdriver, software, operating instructions, calibration certificate and carrying case
346 30 000	Proceq DY-225 Pull-off tester 25 kN (5620 lbf) including: battery pack, battery charger with USB-cable, test disc aluminium Ø 50mm/M10, draw bolt M10, torx screwdriver, software, operating instructions, calibration certificate and carrying case

7.2 Test Discs and Accessories

346 10 500S	Test disc steel, Ø 50mm/M10, set of 10
346 10 501S	Test disc aluminum, Ø 50mm/M10, set of 10
346 10 502S	Test disc aluminum, Ø 20mm/M10, set of 10
346 10 503S	Test disc aluminum, 50x50mm/M10, set of 10
346 10 504S	Test disc aluminum, 40x40mm/M10, set of 10
346 10 505S	Test disc aluminum, Ø 100mm/M10, set of 3
346 10 506S	Test disc aluminum, 100x100mm/M10, set of 3
346 10 507S	Test disc aluminum, Ø 75mm/M10, set of 5
346 10 250	Draw bolt M10 short for Proceq DY-2
346 10 520	Draw bolt M8 short for Proceq DY-2
346 10 521	Draw bolt M12 short for Proceq DY-2
346 10 530	Adapter plate for large test discs
346 10 220	Battery pack complete
346 10 550	Fixing kit for vertical and overhead surfaces



Note: Proceq test discs require an M10 draw bolt. The M8 and M12 draw bolts are for use with test discs not supplied by Proceq. For the 25kN instrument an M10 draw bolt is required for forces above 16kN.

8. Technical Specifications

	Maximum Tensile Force	Maximum Pulling Speed
Proceq DY-206	6 kN 1349 lbf	4.65 mm/min 0.183 inch/min
Proceq DY-216	16 kN 3597 lbf	
Proceq DY-225	25 kN 5620 lbf	2.2 mm/min 0.086 inch/min
Max stroke	5 mm	
Calibration accuracy	EN ISO 7500-1 Class 1 ($\pm 1\%$ from 20% of max. Force)	
Memory capacity	100 measurements	
Battery capacity	1500 mAh, 3.7V (min. 80 measurements)	
Charger connection	USB type A (5V, 500mA)	
Weight	4.5 kg	
Dimensions of housing	109 x 240 x 205.5 mm	
Operating temperature	-10 to 50°C (14 to 122°F)	
Storage temperature	-10 to 70°C (14 to 158°F)	
IP classification	IP54	

8.1 Maintenance and Support

Maintenance

To ensure reliable and accurate operation, it is recommended to have the instrument serviced and re-calibrated on a yearly basis. Customers may however determine their own service interval based on application and usage. The instrument assists with determining a suitable interval by giving a warning on start-up after 1500 complete test cycles.



Support Concept

Proceq is committed to providing a complete support service for this instrument by means of our global service and support facilities. It is recommended that the user register the product on www.proceq.com to obtain the latest on available updates and other valuable information.

8.2 Standard Warranty and Extended Warranty

The standard warranty covers the electronic portion of the instrument for 24 months and the mechanical portion of the instrument for 6 months. An extended warranty for one, two or three years for the electronic portion of the instrument may be purchased up to 90 days of date of purchase.

9. DY-Link Software

Installing DY-Link



Locate the file “DY-Link Setup.exe” on your computer or on the CD and click on it. Follow the instructions you see on the screen.

Make sure that the “Launch USB Driver install” tick is selected.

Starting DY-Link and viewing data stored on Proceq DY-2.



Double click on the DY-Link icon on your desktop or start DY-Link via the start menu. DY-Link starts with a blank list.

Application settings

The menu item “File–Application settings” allows the user to select the language and the date and time format to be used.

Download Data



Connect the Proceq DY-2 to a USB port, then click on this icon to download all data from the instrument.

Data							
Slot ID	ID	Date & Time	Measured value	Dolly Area	Dolly Ø	Ramp	Unit
1	1	01/01/2000 12:05 AM	10.00 kN	1963 mm2	50.0 mm	300 N/s	kN
2	2	01/01/2000 12:09 AM	2252 lbf	3.04 in2	1.97 in	67 lpf/s	lbf
3	3	01/01/2000 8:00 PM	10.21 MPa	1963 mm2	50.0 mm	204 kPa/s	MPa
4	4	01/01/2000 8:04 PM	1480 PSI	3.04 in2	1.97 in	30 PSI/s	PSI
5	5	02/01/2000 2:56 AM	4.61 N/mm2	1963 mm2	50.0 mm	0.204 N/mm2s	N/mm2
6	6	02/01/2000 2:56 AM	9.05 kN	1963 mm2	50.0 mm	400 N/s	kN

Click on the double arrow icon in the “Slot No.” column to see the load rate graph.

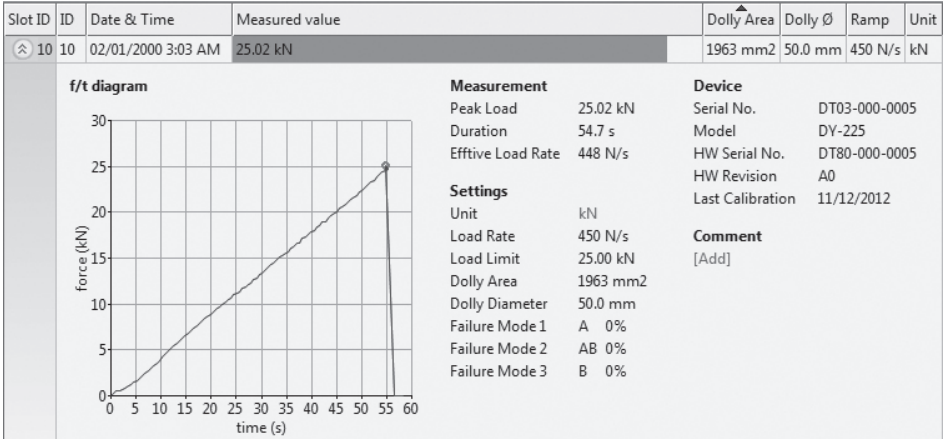

Note: Click on "Add" to attach a comment to the object.

DY-Link also provides the user with a "Summary" window. This is useful for comparing a series of tests.

To include or exclude a measurement from the summary, click on the summary symbol in the Slot ID column. This symbol is either "black" or "greyed out", which shows whether or not the measurement is included in the summary. In order to make a summary, all selected series have to have the same unit.

Exporting data

DY-Link allows you to export selected objects or the entire project for use in third party programs.

Click on the measurement object(s) you wish to export.



Click on the "Export measurements to CSV file(s)" icon. The data for this measurement object(s) is exported as a Microsoft Office Excel comma separated file or files. The export options may be chosen in the following window.



Click on the "Export measurements as graphic file(s)" icon to open the window which allows the various export options to be chosen.

In both cases, a preview window shows the effects of the current output selection.

Finish by clicking on export to select the file location, name the file and in the case of a graphical output to set the output graphic format: .png, .bmp or .jpg

Data editing

The menu item "Edit" allows you to "select all", "copy", "paste" and "delete" measurements from the downloaded data.

Alternatively you can also right click on one or more measurement rows to invoke the context menu which allows you to "cut", "copy", "paste" or "delete" the selected measurements.

Data									
	Slot ID	ID	Date & Time	Measured value		Dolly Area	Dolly Ø	Load Rate	Unit
⌵	1	10	01/01/2000 12:10 AM	16.03		1963 mm2	50.0 mm2	200 N/s	kN
⌵	2	11	01/01/2000 12:12 AM	16.00		1963 mm2	50.0 mm2	200 N/s	kN
⌵	1	10	01/01/2000 12:10 AM	16.03		1963 mm2	50.0 mm2	200 N/s	kN
⌵	2	11	01/01/2000 12:12 AM	16.00		1963 mm2	50.0 mm2	200 N/s	kN

Selected measurements: 1 Total measurements: 4 NUM

For each measurement you can modify the following fields:

- ID (double click)
- Date & Time (right click)
- Unit (right click)

Deleting data stored on the Proceq DY-2

Select the menu item "Device – Delete all measurements object on Proceq DY-2" to delete all data stored on the Proceq DY-2. A warning will be given when all of the data is about to be deleted. Confirm to delete. It is not possible to delete individual series.

Further functions

The following menu items are available via the icons at the top of the screen:



"PQUpgrade" icon - Allows you to upgrade your firmware via the internet or from local files.



"Open DY-link project file" icon – Allows you to open a previously saved .pqr project.



"Save project" icon – Allows you to save the current project.



"Print" icon – Allows you to print out the project. You may select in the printer dialog, if you want to print out all of the data or selected readings only.

It is also possible to select one of more measurements and copy and paste them between project files using CTR-C and CTRL-V.

Live View Mode

The Live View Mode allows the user to monitor the load increase in real-time when the Proceq DY-2 is connected to a PC.



Note: Once the Live View Mode has started, any changes to the settings on the device (e.g. load rate, max load, unit, dolly area) will not be reflected in the measurement plot until the Live View Mode is stopped and restarted.

Click on the “Live View” icon to open the dialog:

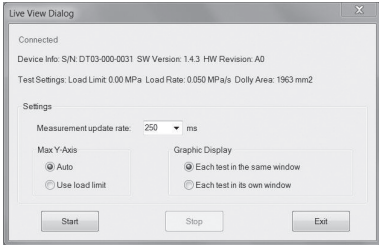

The measurement update rate determines how many data points are used to build up the curve.

The Max Y-axis may be set either at automatic or using the maximum load setting on the instrument.

The default setting is to use a single window to show the load rate. If you wish to make comparisons between more than one test, then each subsequent test can be opened in its own window.

Press start to open the Live View window:

Start the test on the Proceq DY-2 and the load increase will be displayed in real-time until the test is completed

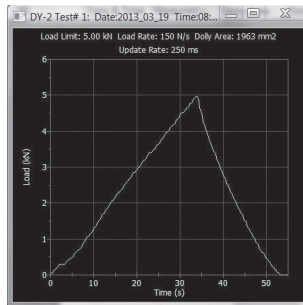
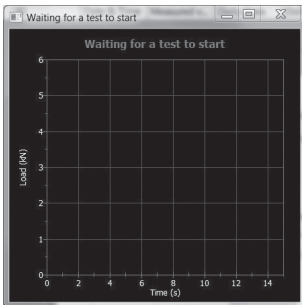

Note: This curve is for monitoring purposes only. You have to perform a download of the saved measurements from the Proceq DY-2 to see the saved curve data.

Calibration

Proceq Proceq DY-2 is calibrated according to EN ISO 7500-1 Annex C - Alternative Method of Testing Machine Classification.

This software allows a re-calibration or a reset to an earlier saved calibration. Typically this will only be performed by a service centre or calibration laboratory.

Separate Operating Instructions describing the calibration procedure can be found under the "Help" menu.

Proceq Europe

Ringstrasse 2
CH-8603 Schwerzenbach
Phone +41-43-355 38 00
Fax +41-43-355 38 12
info-europe@proceq.com

Proceq UK Ltd.

Bedford i-lab, Priory Business Park
Stannard Way
Bedford MK44 3RZ
United Kingdom
Phone +44-12-3483-4515
info-uk@proceq.com

Proceq USA, Inc.

117 Corporation Drive
Aliquippa, PA 15001
Phone +1-724-512-0330
Fax +1-724-512-0331
info-usa@proceq.com

Proceq Asia Pte Ltd

12 New Industrial Road
#02-02A Morningstar Centre
Singapore 536202
Phone +65-6382-3966
Fax +65-6382-3307
info-asia@proceq.com

Proceq Rus LLC

Ul. Optikov 4
korp. 2, lit. A, Office 410
197374 St. Petersburg
Russia
Phone/Fax + 7 812 448 35 00
info-russia@proceq.com

Proceq Middle East

P. O. Box 8365, SAIF Zone,
Sharjah, United Arab Emirates
Phone +971-6-557-8505
Fax +971-6-557-8606
info-middleeast@proceq.com

Proceq SAO Ltd.

South American Operations
Alameda Jaú, 1905, cj 54
Jardim Paulista, São Paulo
Brasil Cep. 01420-007
Phone +55 11 3083 38 89
info-southamerica@proceq.com

Proceq Trading (Shanghai) Co.

Unit B, 19th Floor
Five Continent International Mansion, No. 807
Zhao Jia Bang Road
Shanghai 200032
Phone +86 21-63177479
Fax +86 21 63175015
info-china@proceq.com

Subject to change without notice. Copyright © 2014 by Proceq SA, Schwerzenbach. All rights reserved.
Part number: 82034601E ver 12 2014