

CS3-PM POTENTIOMETER Indicator (24x48) ADtek

Miniature Indicator(24x48mm)



DESCRIPTION

CS3-PM Potentiometer Indicator has been designed in miniature size(24 x 48mm), and provide high accuracy 0.04% measurement, display and communication of Potentiometer(Ohm 3 wire).

They are also building in 2 Relay outputs, 1 External Control Input, 1 Analogue output or 1 RS485(Modbus RTU Mode) interface with versatile functions such as control, alarm, re-transmission or communication for a wide range of position applications.

FEATURE

- Measuring potentiometer signal **0~50Ω/~2.0KΩ; 0~2.0KΩ/~100.0KΩ** (3 wire)
- Field calibration with potentiometer to meet the system requirement
- 2 relay can be programmed individual to be a Hi / Lo / Hi Latch / Lo Latch energized with Start Delay / Hysteresis / Energized & De-energized Delay functions, or to be a remote control.
- Analogue output or RS 485 communication port available in option
- 1 external control input can be programmed to be Relative PV(Tare) / PV Hold / DI (remote monitoring) / Reset for Maximum or Minimum Hold / Reset for Relay Energized Latch....
- CE Approved & RoHS

APPLICATIONS

- Testing Equipments for thickness Measuring, Alarm, Control and Communication with PC/PLC.
- Position control for Valve, Gate or various applications.

ORDERING INFORMATION



Optional Function Customize function is welcome. Please contact with our sales for detail.

CODE	I/P RANGE	CODE	RELAY O/P	CODE	ANALOG O/P	CODE	AXU. POWER
P1	0 Ω ~ 50.0 Ω / ~ 2.0 KΩ	N	None	N	None	ADH*	AC/DC 85~264V
P2	0 Ω ~ 2.0 KΩ / ~ 100.0 KΩ	R1	1 Relay	V	0(1) ~ 5 V / 0 ~ 10 V	ADL*	AC/DC 20~56V
PO	Specify input range	R2	2 Relay	I	0 ~ 10 mA / 4(0)~20 mA		
				8	RS 485		

TECHNICAL SPECIFICATION

Input

Measuring Range	Input Impedance	Excitation Volt
0 Ω ~ 50 Ω / ~ 2.0 KΩ(3 wire)	≥ 1M ohm	About 0.2V
0 Ω ~ 2.0 KΩ / ~ 100.0 KΩ(3 wire)		About 1.6V

Calibration:

Digital calibration by front key

Field calibration:

Calibration with sensor input high & low to meet system structure. And field calibration reset is not change the accuracy & linear of factory calibration.

A/D Converter:

16 bits resolution

Accuracy:

± 0.04% of FS ± 1C;

Sampling Rate:

15 cycles/sec

Response Time:

≤ 100 msec.(when the AvG = "1") in standard

Input Range:

Input High and Low programmable
 Ai.Hi: Settable range: 0.00~100.00% of input range
 Ai.Lo: Settable range: 0.00~100.00% of input range

Display functions

LED:

Numeric: 5 digits, 0.4"(10.0mm)H red high-brightness LED
 Relay output indication: 2 square red LED
 RS 485 communication: 1 square orange LED
 E.C.I. function indication: 1 square green LED

Display range:

-19999~+29999;

Scaling Function:

Lo.SC: Low Scale; Settable range: -19999~+29999
 Hi.SC: High Scale; Settable range: -19999~+29999

Decimal point:

Programmable from 0 / 0.0 / 0.00 / 0.000 / 0.0000

Over range indication:

ovFL, when input is over 20% of input range Hi

Under range indication:

ovFL, when input is under 20% of input range Lo

Max / Mini recording:

Maximum and Minimum value storage during power on.

Display functions:

PV / Max(Mini) Hold / RS 485 programmable

Front key functions:

Up key can be set to be a function as E.C.I.

Low Cut:

Settable range: -19999~29999 counts

Digital Fine Adjust:

Pv.Zro: Settable range: -19999~+29999

Pv.SPn: Settable range: -19999~+29999

Reading Stable Function

Average:

Settable range: 1~99 times

Moving Average:

Settable range: 1(None)~10 times

Digital Filter:

Settable range: 0(None)/1~99 times

Control functions(option)

Set points:

Two set-points

Control Relay:

2 Relays FORM-C, 1A/230Vac, 3A/115V

Relay Energized Mode:

Energized levels compare with set-points:

Hi / Lo / Hi.HLd / Lo.HLd programmable

Energized by RS485 command of master: DO programmable

Energized Functions:

Start delay / Energized & De-energized delay / Hysteresis

Energized Latch

Start band(Minimum level for Energizing): 0~9999counts

Start delay time: 0:00.0~9(Minutes):59.9(Second)

Energized delay time: 0:00.0~9(Minutes):59.9(Second)

De-energized delay time: 0:00.0~9(Minutes):59.9(Second)

Hysteresis: 0~5000 counts

External Control Inputs(ECI)

Input mode:

1 ECI points, Contact or open collect input, Level trigger

Functions:

Relative PV(Tare) / PV Hold / Reset for Max or Mini. Hold /

DI / Reset for Relay Energized latch

Debouncing time:

Settable range 5 ~ 255 x 8m seconds

Analogue output(option)

Accuracy:

± 0.1% of F.S.;

Ripple:

± 0.1% of F.S.

Response time:

≤ 100 msec. (10~90% of input)

Isolation:

AC 1.5 KV between input and output

Output range: Specify either Voltage or Current output in ordering
Voltage: 0~5V / 0~10V / 1~5V programmable
Current: 0~10mA / 0~20mA / 4~20mA programmable
Output Capability: **Voltage:** 0~10V: $\geq 1000\Omega$;
Current: 0(4)~20mA: $\leq 600\Omega$ max
Functions: **Ao.HS**(output range high): Settable range: -19999~29999
Ao.LS(output range Low): Settable range: -19999~29999
Ao.LMt(output High Limit): 0.00~110.00% of output High
Ao.Zro: Settable range: -38011~+27524
Ao.SPn: Settable range: -38011~+27524
Digital fine adjust:

RS 485 Communication(optional)

Protocol: Modbus RTU mode
Baud Rate: 1200/2400/4800/9600/19200/38400 programmable
Data Bits: 8 bits
Parity: Even, odd or none (with 1 or 2 stop bit) programmable
Address: 1 ~ 255 programmable
Remote Display: to show the value from RS485 command of master
Distance: 1200M
Terminate Resistor: 150 Ω at last unit.

Electrical Safety

Dielectric Strength: AC 1.5 KV for 1 min, Between Power / Input / Output / Case
Insulation Resistance: $\geq 100M$ ohm at 500Vdc, Between Power / Input / Output
Isolation: Between Power / Input / Relay / E.C.I./ Analogue or RS485
EMC: EN 55011:2002; EN 61326:2003
Safety(LVD): EN 61010-1:2001

Environmental

Operating temp.: 0~60 °C
Operating humi.(%RH): 20~95 %RH, Non-condensing
Temp. coefficient: ≤ 100 PPM/°C
Storage temperature: -10~70 °C
Enclosure: Front panel: IEC 549 (IP54); Housing: IP20

Mechanical

Dimensions: 48mm(W) x 24mm(H) x 102mm(D)
Panel cutout: 45mm(W) x 22.5mm(H)
Case Material: ABS fire-protection (UL 94V-0)
Mounting: Panel flush mounting
Terminal block: Plastic NYLON 66 (UL 94V-0)
 5A 300Vac, M2.0, 0.5~1.3mm²(22~16AWG)
Weight: About 110g

Power

Power Supply: AC/DC 85~264V or AC/DC 20~56V
Power consumption: 4.5VA max.
Back up memory: By EEPROM

FRONT PANEL

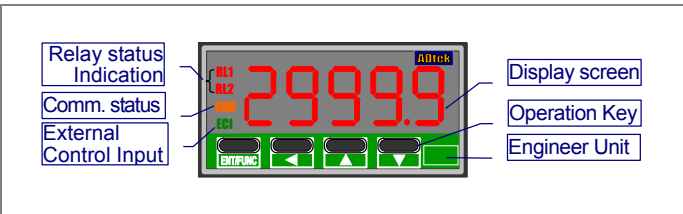

DIMENSIONS

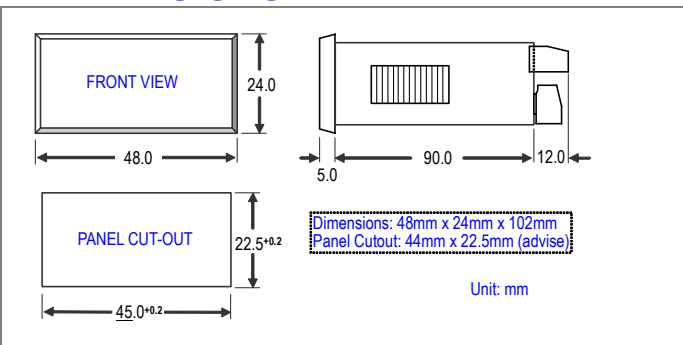

INSTALLATION

The meter should be installed in a location that dose not exceed the maximum operating temperature and provides good air circulation.

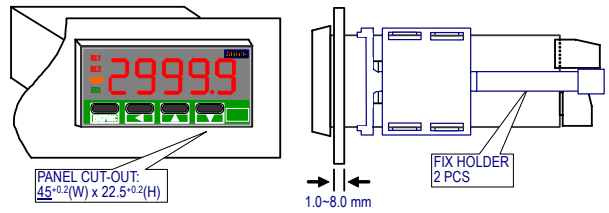

CONNECTION DIAGRAM

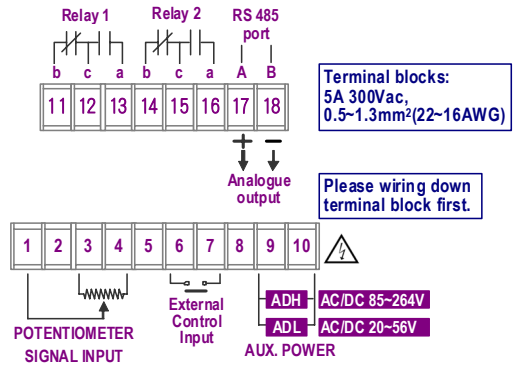

Please check the voltage of power supplied first, and then connect to the specified terminals. It is recommended that power supplied to the meter be protected by a fuse or circuit breaker.

Power Supply

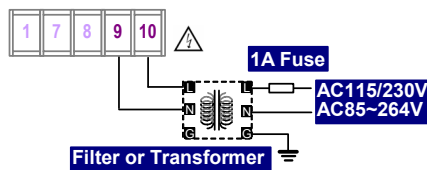

RS485 Communication Port

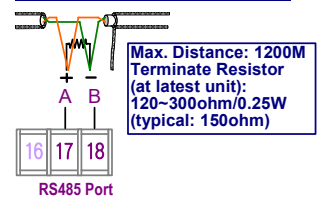

FUNCTIONS DESCRIPTION

Input & Scaling Functions

Input Range:

The meter has to be specified and fixed according to ordering code (ex. 0~10V or 4(0)~20mA) in factory. If the meter has to install in difference range of input, the meter can be set in function **RLo** and **RHi** in **[INPUT GROUP]** to meet the input signal. For example: The meter is 0~10Vdc input, and the signal from sensor is 2~10Vdc. Please get into **[INPUT GROUP]** to set **RLo** (Analogue input Low) to be 20.00%(10V x 20.00% = 2V), then the meter has been changed the input range to 2~10Vdc and the all relative parameters will work base on 2~10V. The meter doesn't need re-calibration after change the **RLo** and **RHi**.

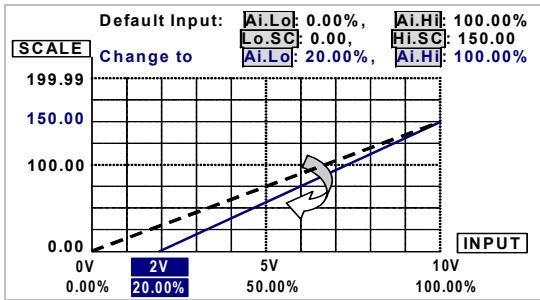

*The setting may cause display lower resolution. Please set lower resolution when the input signal has been high compressed.

Scaling Function:

The high and low of display range can be programmable to relative input signal high and low. Setting the **Lo.Sc** (Low scale) and **Hi.Sc** (High scale) in **[INPUT GROUP]** to relative input signal. **Reverse scaling will be done too.** Please refer to the figure as below,

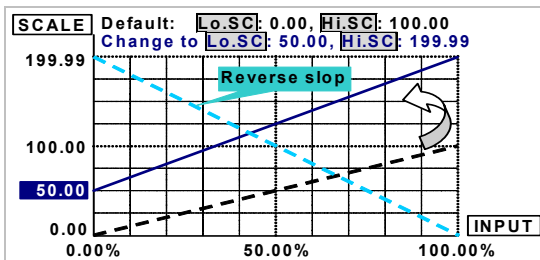

*Too narrow scale may cause display lower resolution.

Display & Functions

Max / Mini recording:

The meter will storage the maximum and minimum value in **[User Level]** during power on in order to review drifting of PV.

Display functions:

(Please refer to step A-09)

PV / Max(Mini) Hold / RS 485 programmable in [DISPLAY function in [INPUT GROUP]

Present Value [P_u]: The display will show the value that Relative to Input signal.

Maximum Hold [M_AH] / Minimum Hold [M_IN]:

The meter will keep display in maximum(minimum) value during power on, until manual reset by front key in **[User Level]**, **[E.C.I]** close by rear terminal (according to setting, please refer to the function of E.C.I. Group) or or press front up key to Reset(Up key set to be same function as ECI1)

- Please find the **[M]** sticker that enclosure the package of the meter to stick on the left side of square orange LED.

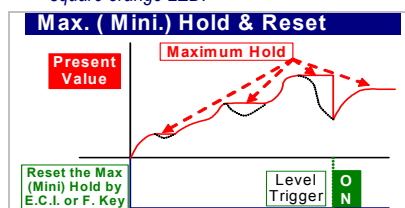

Remote Display by RS485 command [R5485]: The meter will show the value that received from RS485 command. In past, The meter normally receive 4~20mA or 0~10V from AO or digital output from BCD module of PLC. We support a new solution that PV shows the value from RS485 command of master can so that can be **save cost and wiring** from PLC.

PV Hold [P_uHLd] : [E.C.I.] can be set to be **[P_uHLd]** function (Please refer to the function of ECI Group). The display will be hold, when the E.C.I. is closed.

- Please find the **[ECI PM]** sticker to stick on the left side of square green LED.

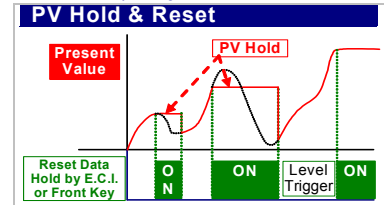

Low Cut:

If the setting value is positive, it means when the absolutely value of $PV \leq$ Setting value, the display will be 0. If the setting value is negative, it means when the PV under setting value ($PV \leq -$ Setting value), the display will be setting value.

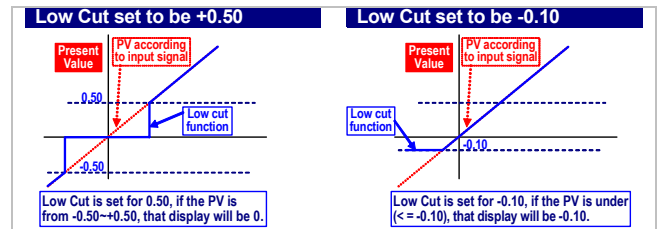

Digital fine adjustment:

Users can get Fine Adjustment for Zero & Span of PV by front key of the meter, and **"Just Key In"** the value which user want to show in the current input signals.

Especially, the **[P_uZero]** & **[P_uSpan]** are not only in zero & span of PV, but also any lower point for **[P_uZero]** & higher point for **[P_uSpan]**. The meter will be linearization for full scale.

The adjustment can be clear in function **[P_uCLR]**.

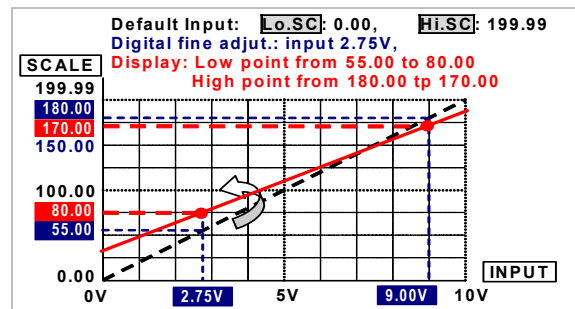

Reading Stable Function

Average:

Basically, the sampling rate of meter is 15cycles/sec. If the function set to be 3 times, It means the meter will update of display will be 5 times/sec.

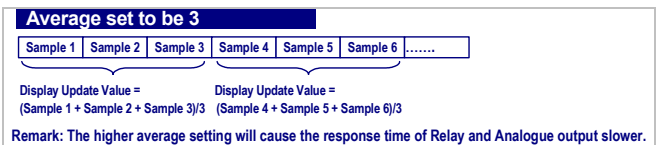

Moving Average:

If the function to be set 3 times, the meter will update delay in first 3 samples, then it will update 15 times/sec continuously.

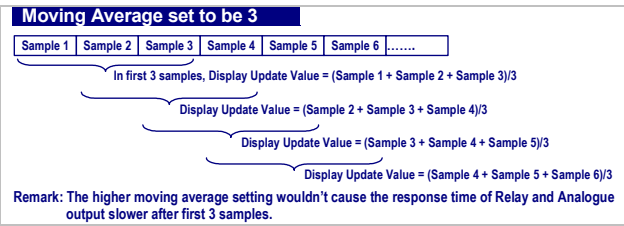

Digital Filter: The digital filter can reduce the magnetic noise in field.

Control Functions(option)

Relay Energized Mode:

In all CS series, the relay functions are not only for alarm or control, but also for I/O interface as like as I/O of PLC. They can be programmed to be Hi(Latch) / Lo(Latch) energized to compare with set-point or DO to be energized by RS485 command directly.

Energized with set-points:

Hi / Lo / Hi.HLd / Lo.HLd programmable

Hi: Relay will energize when PV > Set-Point

Lo: Relay will energize when PV < Set-Point

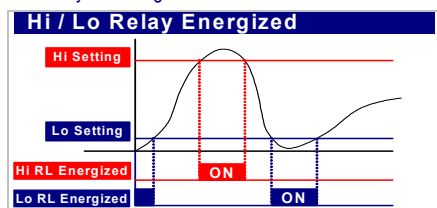

Hi.HLd (Lo.HLd): When the PV Higher (or lower) than set-point, the relay will be energized and latch until manual reset by from key in [User Level], up key (If up key function has been set) or [E.C.I.] close by rear terminal.

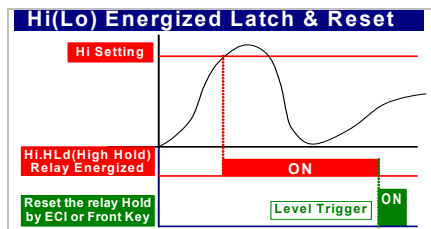

Energized by RS485 command of master: DO function

The DO function was designed to get remote control by RS485 command of master. The typical application is to control a switch in field from computer center as like as digital output(DO) of PLC.

Energized Functions: Start delay / Energized & De-energized delay / Hysteresis

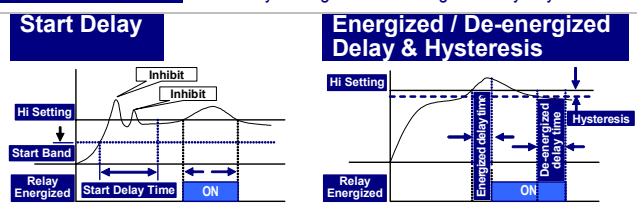

External Control Inputs(ECI)

The one external control input is programmable to perform specific meter control or display functions. The E.C.I. has been designed in level trigger actions. Please pay attention, the ECI input will be disable while UP or Down Key has been set to be "YES".

Functions:

Relative PV / PV Hold / Reset Max or Mini. Hold / DI / Reset for Relay Energized latch; programmable

Relative PV or Tare: The E.C.I. can be set to be **rELPu** function. When the E.C.I. is closed, the reading will show the differential value until it's open.

PV Hold: The E.C.I. can be set to be **PuHLd** function. The display will be hold when the E.C.I. is closed, until the E.C.I. is to be open. Please refer to the figure on following;

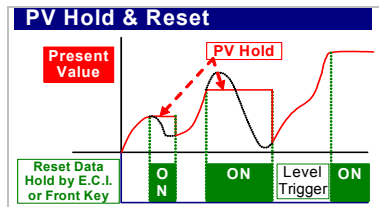

Reset for Maximum or Minimum Hold: When the [dSPly] function in [mPUtE GrOuP] selected **nARh** or **nIRh**, the display will show Maximum or Minimum value, and can be reset by the E.C.I. Please refer to the figure as below;

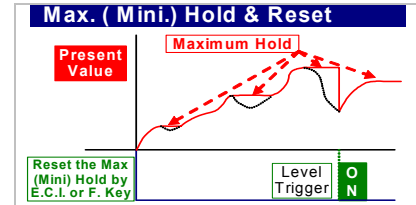

DI: The E.C.I. can be set to be **dI** function. when the meter build in RS485 port, It is easier to get remote monitoring a switch status through the meter as like as DI of PLC.

Reset for Relay Energized Latch: If relay energized mode has set to be Energized latch(**HLd** / **LoHLd**), the E.C.I. can be set to be **r4.r5t**. When the PV meets the condition of relay energizing, the relay will be energized and latch until the E.C.I. is closed.

Debouncing time:

The function is for avoiding noise signal to into the meter. And The basic period is 8m seconds. It means you set the number that has to multiple 8m seconds. For example: **[dEbnC]** set to be 5, it means 5 x 8m seconds = 40m seconds

Analogue output(option)

Please specify the output type either an 0~10V or 4(0)~20mA in ordering. The programmable output low and high scaling can be based on various display values. **Reverse slope output is possible by reversing point positions.**

Output range:

Voltage: 0~5V / 0~10V / 1~5V programmable

Current: 0~10mA / 0~20mA / 4~20mA programmable

Ao.HS(output range high): setting the Display value High to versus output range High(as like as 20mA in 4~20)

Ao.LS(output range Low): setting the Display value Low to versus output range Low(as like as 4mA in 4~20)

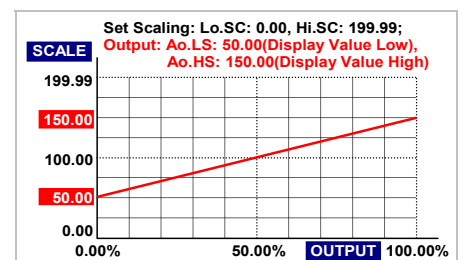

The range between **Ao.HS** and **Ao.LS** should be over 20% of span at least; otherwise, it will be got less resolution of analogue output.

Ao.LMt(output High Limit): 0.00~110.00% of output High

User can set the high limit of output to avoid a damage of receiver or protection system.

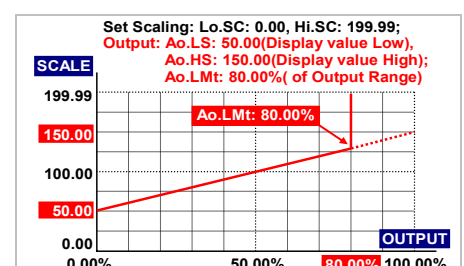

Fine zero & span adjustment:

Users can get Fine Adjustment of analogue output by front key of the meter. Please connect standard meter to the terminal of analogue output. To press the front key(up or down key) of meter to adjust and check the output.

RS 485 communication(optional)

The RS485's protocol is Modbus RTU mode, and baud rate up to 38400 bps. It's not only convenience to remote monitoring, display for reading and ECI status, but also for remote control in the case that doesn't have any DIO device in the field.

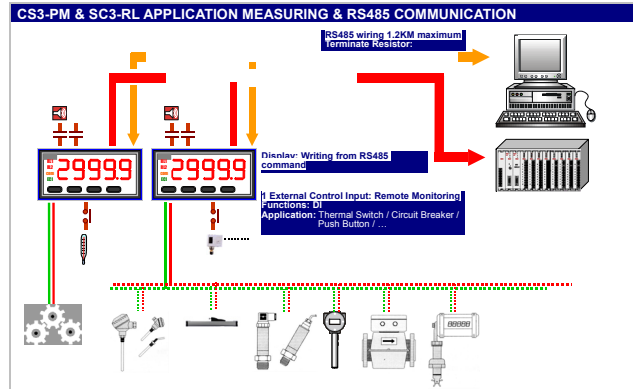

Remote Display:

The meter will show the value that received from RS485 command. In past, The meter normally receive 4~20mA or 0~10V from AO or digital output from BCD module of PLC. We support a new solution that PV shows the value from RS485 command of master so that can be **save cost and wiring** from PLC.

When the [d5PLY] set to be RS485, it means, the PV screen will show the value from RS485 command & data. The data(number) will be same as PV that will compare with set-point, analogue output and ECI functions so that is to control analogue output, relay energized and so on.

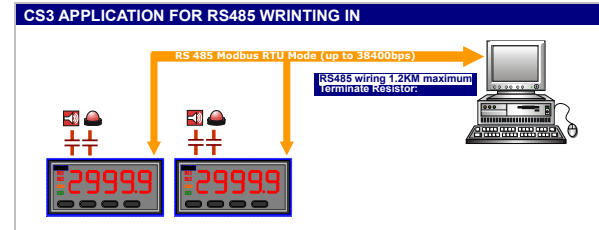

Calibration

System calibration by front key. The process of calibration, please refer to the operating manual

Field Calibration

In pass time, engineers have take a lot of time to adjust meters or converter to meet the structure of machinery zero and span for the Load Cell measuring. Now, our CS3-PM support easier process to do it called "Field Calibration".

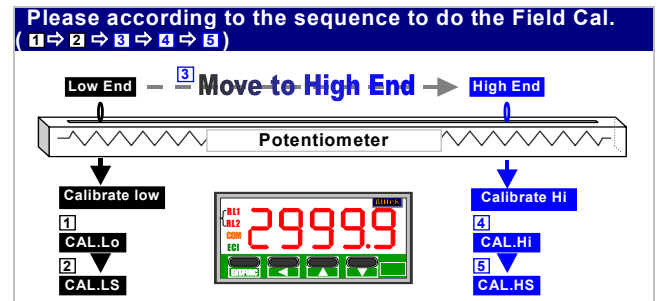

■ ERROR MASAGE

DESCRIPTION	DISPLAY	FLASH	REMARK
BEFORE POWER ON, PLEASE CHECK THE SPECIFICATION AND CONNECTION AGAIN.			
SELF-DIAGNOSIS AND ERROR CODE:			
ouFL : Display is positive-overflow (Signal is over display range)	ouFL		(Please check the input signal)
-ouFL : Display is negative-overflow (Signal is under display range)	-ouFL		(Please check the input signal)
ouFL : ADC is positive-overflow (Signal is higher than input high 20%)	ouFL		(Please check the input signal)
-ouFL : ADC is negative-overflow (Signal is lower than input low 20%)	-ouFL		(Please check the input signal)
EeP / FAiL : EEPROM occurs error	EeP	FAiL	(Please send back to manufactory for repaired)
AiL.nG / Pu : Calibrating Input Signal do not process	AiL.nG	Pu	(Please process Calibrating Input Signal)
AiC. / FAiL : Calibrating Input Signal error	AiC.	FAiL	(Please check Calibrating Input Signal)
AO.nG / Pu : Calibrating Output Signal do not process	AO.nG	Pu	(Please process Calibrating Output Signal)
AiC. / FAiL : Calibrating Output Signal error	AiC.	FAiL	(Please check Calibrating Output Signal)

FRONT PANEL:

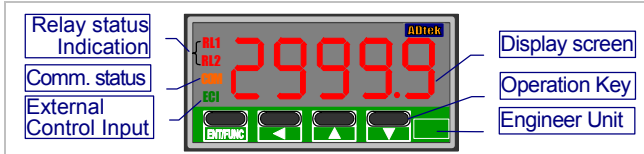

Numeric Screens

0.4"(10.0mm) red high-brightness LED for 4 2/3 digital present value.

I/O Status Indication

- **Relay Energized:** 2 square red LED
 - RL1** display when Relay 1 energized;
 - RL2** display when Relay 2 energized;
- **External Control Input Energized:** 1 square green LED
 - ECI1** display when E.C.I. 1 close(dry contact)
- **RS485 Communication:** 1 square orange LED
 - COM** will flash when the meter is receive or send data, and **COM** flash quickly means the data transient quicker.

Stickers:

Each meter has stickers what are functions and engineer label enclosure.

- **Relay energized mode:** **HH** **Hi** **Lo** **LL** **DO**
- **E.C.I. functions mode:**
 - PV.H** PV.H(PV Hold) / **Tare** Tare / **DI** DI(Digital Input) /
 - M.RS** M.RS(Reset for Maximum or Minimum hold) /
 - R.RS** R.RS(Reset for Relay Latch)
- **Engineer Label:** over 80 types.

- **Operating Key:** 4 keys for **ENT/FUN** Enter(Function) / **Shift**(Escape) / **Up** key / **Down** key

	Setting Status	Function Index
Up key	Increase number	Go back to previous function index
Down key	Decrease number	Go to next function index
Shift key	Shift the setting position	Go back to this function index, and abort the setting
ENT/FUN key	Setting Confirmed and save to EEPROM	From the function index to get into setting status

- **Pass Word:** Settable range:0000~9999;

User has to key in the right pass word so that get into **[Programming Level]**. Otherwise, the meter will go back to measuring page. If user forgets the password, please contact with our service window.

- **Function Lock:** There are 4 levels programmable.

- **None:** no lock all.
- **User Level:** User Level lock. User can get into User Level for checking but setting.
- **Programming Level:** Programming level lock. User can get into programming level for checking but setting.
- **ALL:** All lock. User can get into all level for checking but setting.

Front Key Function

- The **ENT/FUN** Key can be set to be the same function as the setting of ECI1.
Ex. The ECI1 set to be **PuHLd** and the function E.1=UP set to be **YES** in **[ECI GroUP]**. When user presses **ENT/FUN** Key, the PV will hold as like as ECI1 close.
- **If the front key function has been set, the terminal input for ECI will be disabling.**

OPERATING DIAGRAM(The detail description of operation, please refer to operating manual.)

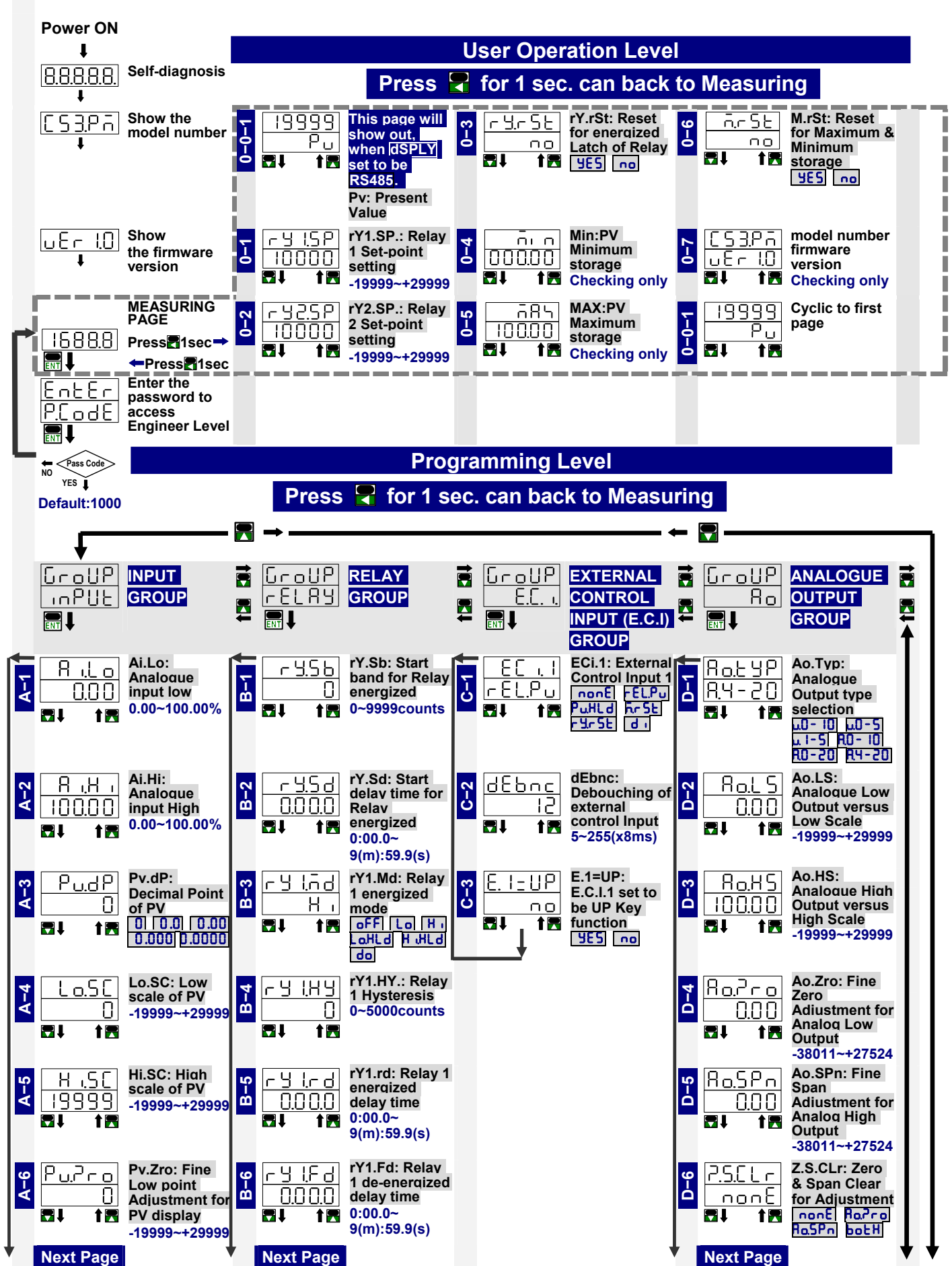

A-7	Pv.SPn 0	Pv.SPn: Fine High point Adjustment for PV display -19999~+29999	B-7	rY2.Md H	rY2.Md: Relay 2 energized mode bFF Lo H LoHLd H.HLd do
A-8	Z.S.Clr none	Z.S.Clr: Clear Fine Zero & Span Adjustment for PV display none PuPro PuSPn both	B-8	rY2.HY 0	rY2.HY: Relay 2 Hysteresis 0~5000counts
A-9	dSPLY Pu	dSPLY: Display Function Pu non.H n.H F5485	B-9	rY2.rd 0000	rY2.rd: Relay 2 energized delay time 0:00.0~9(m):59.9(s)
A-10	Lo.Cut 0	Lo.Cut: Low Cut Function -19999~+29999	B-10	rY2.Fd 0000	rY2.Fd: Relay 2 de-energized delay time 0:00.0~9(m):59.9(s)
A-11	AvG 5	AvG: Average update for PV 1(None)~99 times			
A-12	M.AvG 1	M.AvG: Moving Average update for PV 1(None)~10 times			
A-13	d.FiLt 0	d.FiLt: Digital filter 0(None)/1~99 times			
A-14	P.Code 0000	P.Code: Pass Code for enter Programming Level 0000~9999			
A-15	F.LoCk none	F.LoCk: Function Level Lock none USER Eng ALL			

D-7	Ao.LMt 110.00	Ao.LMt: Analog Output High Limit 0.00~110.00%
E-1	AdRES 1	AdRES: Device number of the meter 1~255
E-2	baUD 9600	baUD: Baud rate 1200 2400 4800 9600 19200 38400
E-3	Prity n.Stb.2	Prity: Parity n.Stb.1 n.Stb.2 odd EvEn

GROUP RS485 GROUP

- > Plesae refer to operating manual for detail description.
- > The process of Field Calibration is discription in manual.