



CPM-20

MULTIFUNCTION

POWER METER

CPM-20 Operation Manual

DESCRIPTION

The CPM-20 series Multifunction Power Meter provide high accuracy measurement, display and communication(Modbus RTU) of all electrical and power quality parameters, including harmonic measurement THD(Total Harmonic distortion)

Provides electricity bill ratio (Cost) and CO₂ set can show cumulative electricity bills and carbon emissions, and suitable for the installation in the power management of remote communication, such as the use of demand.

APPLICATION

Control panels and Motor, Generator monitoring Switchgear distribution systems , Energy Management Power quality analysis

Front Panel

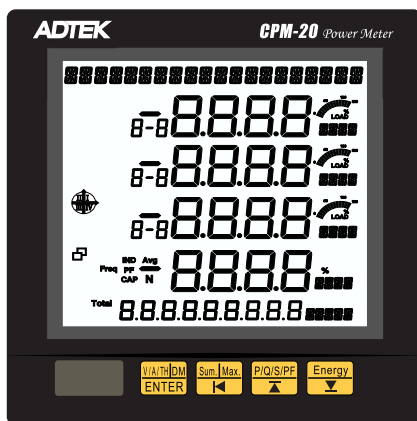

Control button:



ENTER / Voltage /Current display page



Shift / Main electric parameters display page



UP / Electric parameters display page



Down / Energy parameters display page

Passwords:4 digits passwords ; Range : 0000~9999

Display : LCD 65(W)x61(H)mm ; White backlight ; Blue wording
Visible under direct sunlight

LCD LED : Backlight on time 0~15Min

Upper row 20 digits : Display date. time

8888: 4 Digitsx 4 rows, Display value

8888888888: 9 Digits x 1 row, Display Energy parameters

: Rs485 communication status ; 2 square status icons
Display Master and Slave status ;

Load status indication: IND :load is inductive

CAP:load is capacitive

LOAD%:Display load percentage :Display load quadrant

R - b ,b - c ,c - A:When on ,value showing Line-Line

R ,b ,c :When on ,value showing in Phase

N :When on ,value showing in Neutral

Total :When on ,value showing Total value

Avg :When on ,value showing Average

THD :When on ,value showing Total harmonics distortion

.. :LED-16 byte display parameters Unit

Dimensions

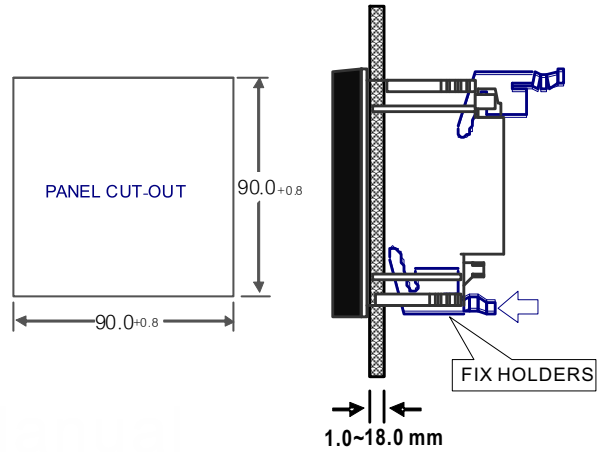
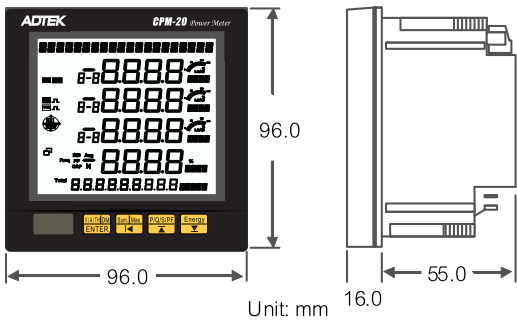

Connection diagram

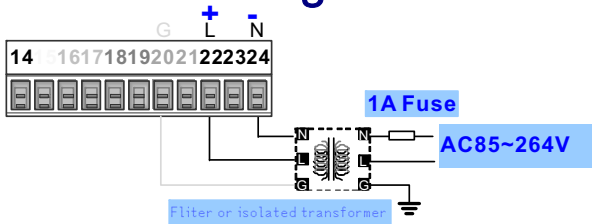

Rs485 Port

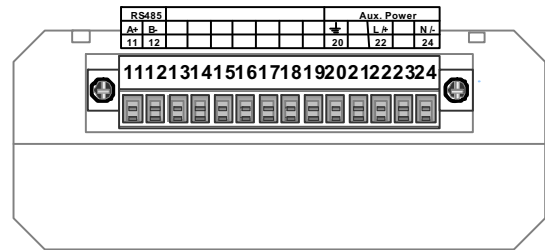
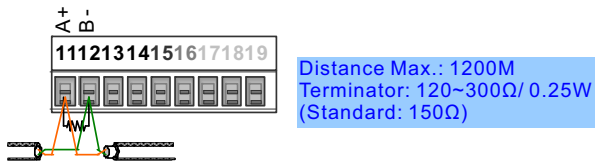

3P4W-3PT/3CT [SET: 3 P 4 W 1]

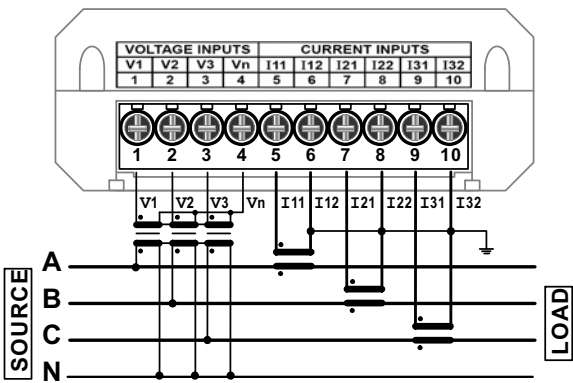

3P4W-Direct Voltage NOPT/3CT [SET: 3 P 4 W 1]

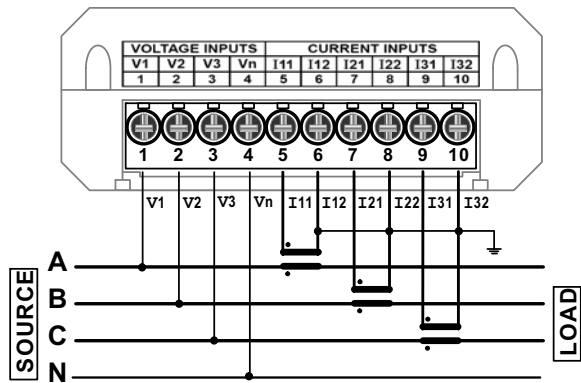

3P3W(Balanced load)-3PT/1CT[SET: 3 P 4 W 1]

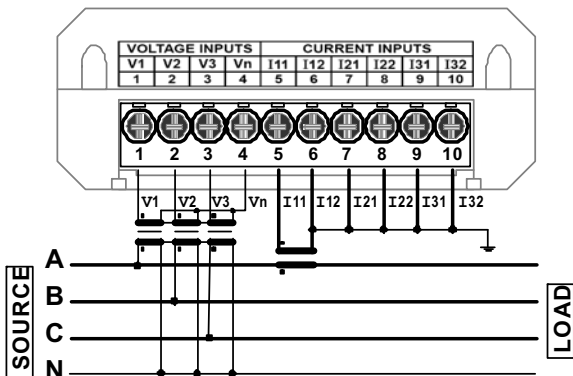

3P4W(Balanced load)-Direct Voltage NOPT/1CT [SET: 3 P 4 W 1]

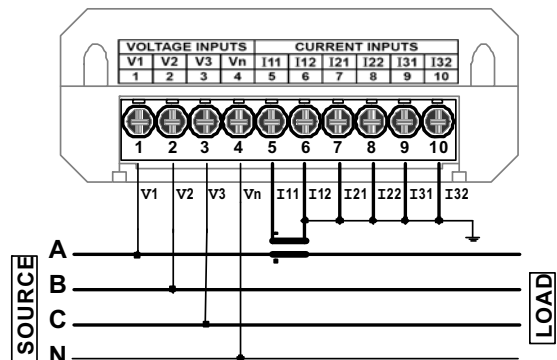

Connection diagram

3P3W-2PT/3CT [SET: 3 P 3 4 3]

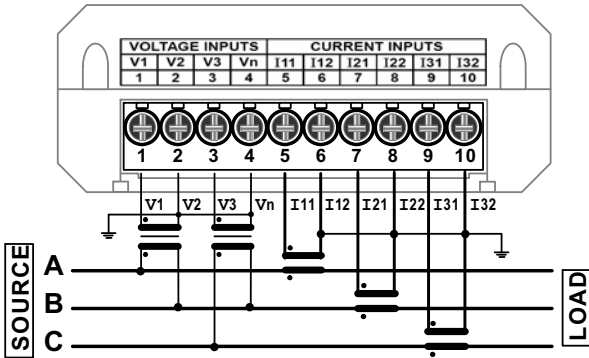

3P3W-Direct Voltage NOPT/3CT [SET: 3 P 3 4 3]

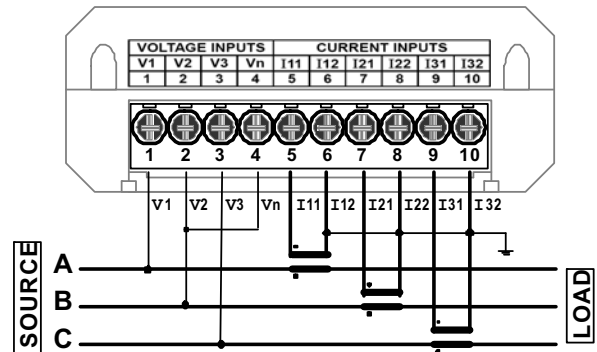

3P3W-2PT/2CT [SET: 3 P 3 4 1]

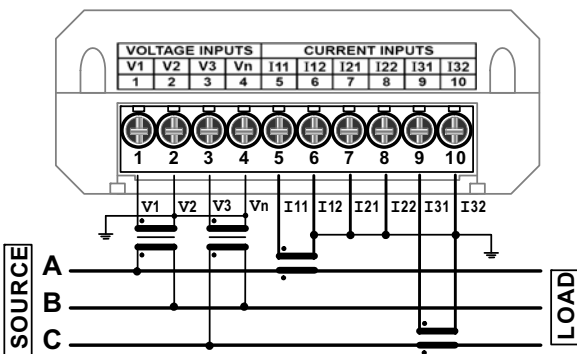

3P3W-Direct Voltage NOPT/2CT [SET: 3 P 3 4 1]

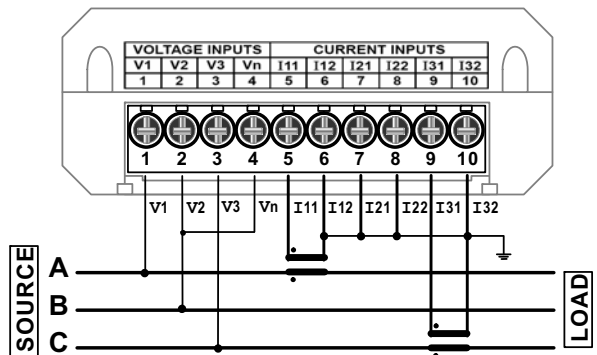

This CT wiring can be use for inverter load or any usual circumstancs

3P3W-2PT/2CT [SET: 3 P 3 4 3]

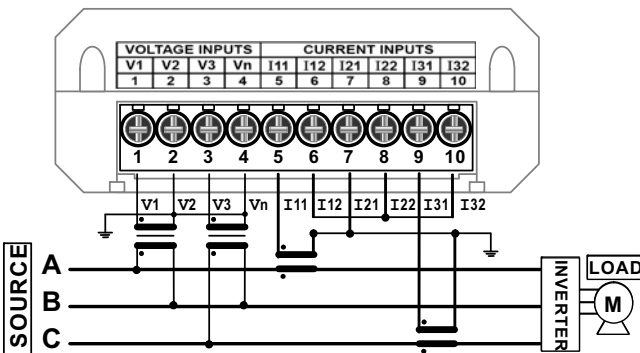

3P3W-Direct Voltage NOPT/2CT [SET: 3 P 3 4 3]

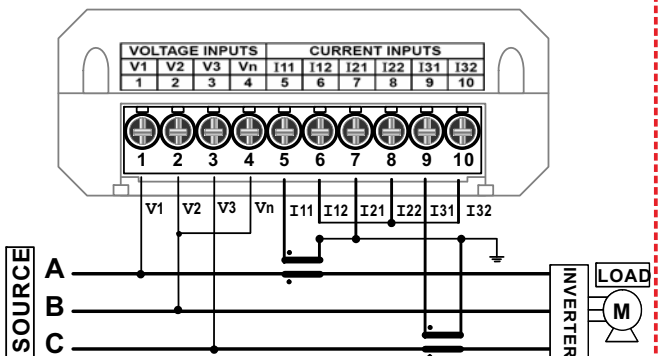

3P3W(Balanced load)-2PT/1CT [SET: 3 P 3 4 6]

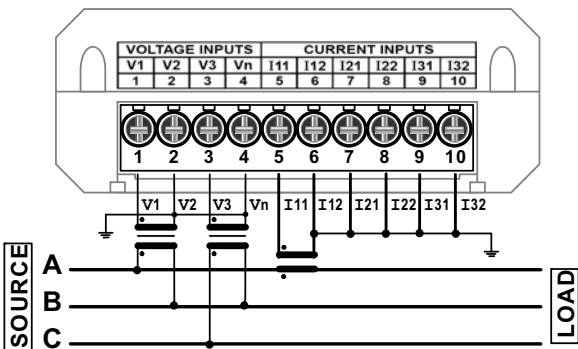

3P3W(Balanced load)-Direct Voltage NOPT/1CT [SET: 3 P 3 4 6]

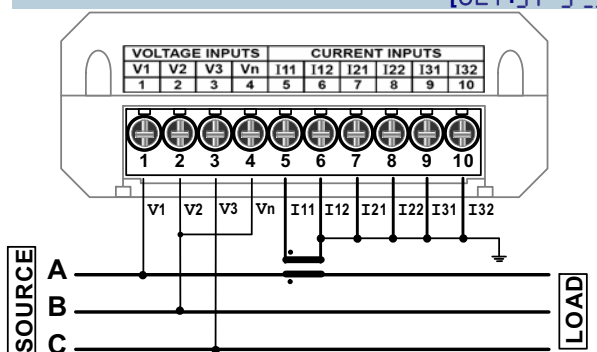

Connection diagram

1P2W- [SET : 1P 2W]

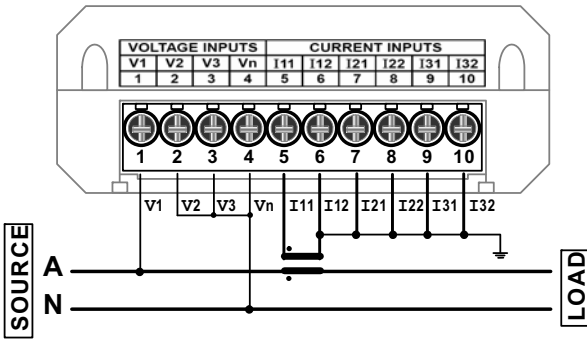

1P3W- [SET : 1P 3W]

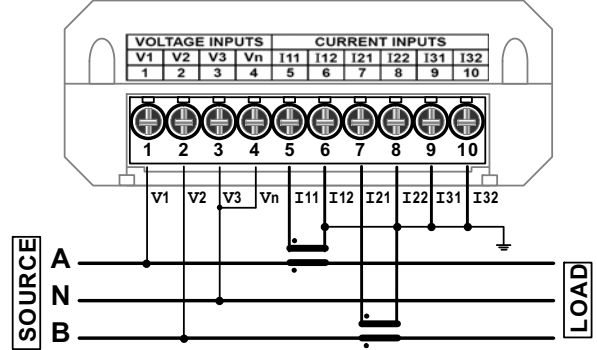

Operational processes

Key definition:



ENTER / Volt. (voltage)/AMP. (current)
 Shift: Shift left / Total (Comprehensive)
 Up: Move Up / Power
 Down: Move Down / Energy

Confirm wiring
Power transmission

Display
Models and versions

Permanent Mission of
the screen display

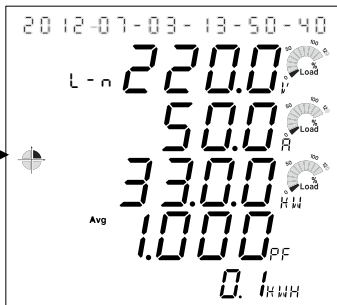

The permanent screen Please refer to the H-1 set Item Description

Press V/A/T/H/D/M ENTER Key

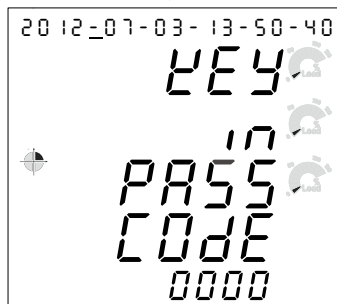

P.COD
Default: 1000

Press V/A/T/H/D/M ENTER Key

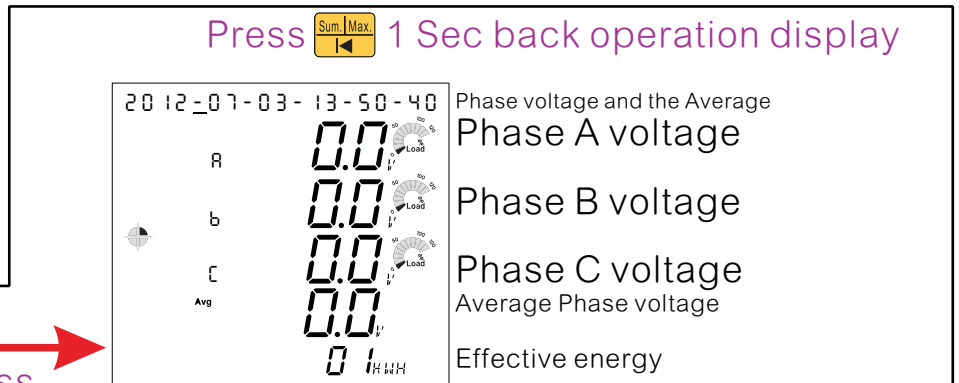
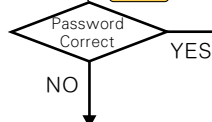

General operating class

Press V/A/T/H/D/M ENTER Key

Voltage, Current, Total harmonic display group

Press Sum | Max. Key

Integrated display group
 (3P3W/3P3W.B/3P3W3 No such function)

Press P/Q/S/PF Key

Power display group

Press Energy Key

Electricity, Time display group

Parameter setting class

A1~A6 Input group

P/Q/S/PF KEY ↑ Energy KEY ↓

E1~E3 RS485 group

P/Q/S/PF KEY ↑ Energy KEY ↓

F1~F2 Energy group

P/Q/S/PF KEY ↑ Energy KEY ↓

G1~G3 Time group

P/Q/S/PF KEY ↑ Energy KEY ↓

H1 Permanent screen

P/Q/S/PF KEY ↑ Energy KEY ↓

G1 INIT group

Press **VIA TH DM** **ENTER** key (Voltage and Current harmonics screen)

Normal screen **Sum | Max** 1 seconds, first showed off the voltage value As follows

20 12-07-03-13-50-40

R 0.0 V Phase voltage and the Average Phase A voltage

b 0.0 V Phase B voltage

c 0.0 V Phase C voltage

Avg 0.0 V Average Phase voltage

01 kWh Active energy

Press **VIA TH DM** **ENTER** Key ↓

20 12-07-03-13-50-40

R - b 0.0 V 1.1.1-The Value of the Line voltage and the Average Line voltage A-B Line Voltage

b - c 0.0 V B-C Line Voltage

c - R 0.0 V C-A Line Voltage

Avg 0.0 V Average line voltage

01 kWh Active energy

Press **VIA TH DM** **ENTER** Key ↓

20 12-07-03-13-50-40

R 0.0 % THDU 1.1.2-Voltage total harmonic distortion Phase voltage total harmonic THDU/ Phase A THD

b 0.0 % THDU THDU/ Phase B THD

c 0.0 % THDU THDU/ Phase C THD

Avg 0.0 % THDU Average line voltage THD

01 kWh Active energy

Press **VIA TH DM** **ENTER** Key ↓

20 12-07-03-13-50-40

R 0.000 A 1.1.3-Phase current values and the average Phase A current

b 0.000 A Phase B current

c 0.000 A Phase C current

Avg 0.000 A Average current

01 kWh Active energy

20 12-07-03-13-50-40

R 0.000 A 1.1.4-Phase Current and Neutral Current Phase A current

b 0.000 A Phase B current

c 0.000 A Phase C current

N 0.000 A Neutral Current

01 kWh Active energy

Press **VIA TH DM** **ENTER** Key ↓

20 12-07-03-13-50-40

R 0.0 % THDI 1.1.5-Current harmonic distortion rate THDI/Phase A Current THD

b 0.0 % THDI THDI/Phase B Current THD

c 0.0 % THDI THDI/Phase C Current THD

Avg 0.0 % THDI Average Current THD

01 kWh Active energy

Press **VIA TH DM** **ENTER** Key ↓

To 1.1.1 Display Or Press **Sum | Max** **ENTER** Key 1 Sec Back to Measurement screen

Press Shift KEY (Comprehensive screen) Press Up KEY (Power Parameters)

Normal screen 1 seconds, first showed off the voltage value As follows

Phase voltage and the Average
Phase A voltage
Phase B voltage
Phase C voltage
Average Phase voltage
Active energy

Normal screen 1 seconds, first showed off the voltage value As follows

Phase voltage and the Average
Phase A voltage
Phase B voltage
Phase C voltage
Average Phase voltage
Active energy

Press Key ↓

1.2.1-3-phase integrated display-1

Average Phase voltage
Average current
Total Active power
Average power factor
Active energy

Press Key ↓

1.3.1-Effective power display

Phase A active power
Phase B active power
Phase C active power
Total Active power
Active energy

Press Key ↓

1.2.2-3-phase integrated display-2

Average Line voltage
Average current
Total Active power
Average power factor
Active energy

Press Key ↓

1.3.2-Reactive power display

Phase A reactive power
Phase B reactive power
Phase C reactive power
Total reactive power
Reactive electricity

Press Key ↓

1.2.3-3-phase integrated display-3

Total Apparent Power
Total Reactive Power
Total Active power
Average power factor
Active energy

Press Key ↓

1.3.3-Apparent power display

Phase A apparent power
Phase B apparent power
Phase C apparent power
Total Apparent Power
Active energy

Press Key ↓

1.2.4-3-phase integrated display-4

Total Apparent Power
Total Reactive Power
Total Aective power
Frequency
Active energy

Press Key ↓

1.3.4-Power Factor display

Phase A power factor
Phase B power factor
Phase C power factor
Average Power factor
Active energy

Press Key ↓ To 1.2.1 Display Or Press Key 1 Sec Back to Measurement screen

Press Key ↓ To 1.3.1 Display Or Press Key 1 Sec Back to Measurement screen

Press  Down KEY (Power parameters)

Normal screen  1 seconds,
first showed off the voltage value As follows

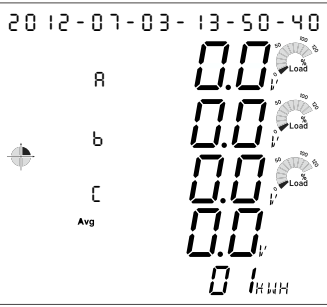

20 12-07-03-13-50-40

R 0.0

b 0.0

c 0.0

Avg 0.0

0.1 kWh

Phase voltage and the Average
Phase A voltage

Phase B voltage

Phase C voltage

Average Phase voltage

Active energy

Press  Key ↓

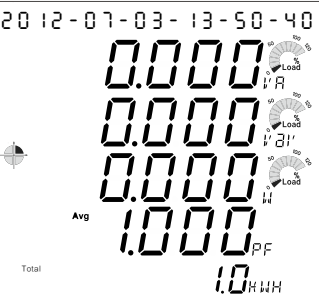

20 12-07-03-13-50-40

0.0000

0.0000

0.0000

Avg 1.0000 PF

Total 1.0 kWh

1.4.1-Power display-1

Total apparent power

Total reactive power

Total active power

Average power factor

Total Active energy

Press  Key ↓

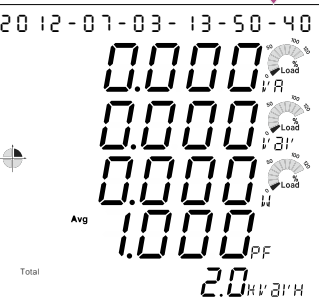

20 12-07-03-13-50-40

0.0000

0.0000

0.0000

Avg 1.0000 PF

Total 2.0 kWh

1.4.2-Power display-2

Total apparent power

Total reactive power

Total active power

Average power factor

Total reactive electricity

Press  Key ↓

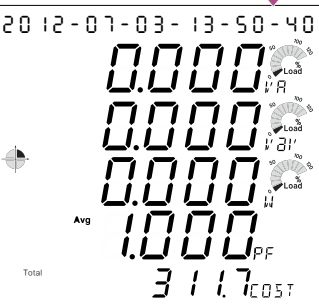

20 12-07-03-13-50-40

0.0000

0.0000

0.0000

Avg 1.0000 PF

Total 311.7 kWh

1.4.3-Total electricity bills display

Total apparent power

Total reactive power

Total active power

Average power factor

Total electricity bill

Press  Key ↓

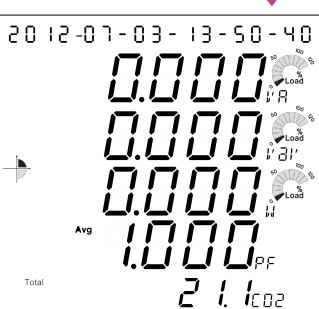

20 12-07-03-13-50-40

0.0000

0.0000

0.0000

Avg 1.0000 PF

Total 21.1 kg CO2

1.4.4-Carbon emissions

Total apparent power

Total reactive power

Total active power

Average power factor

Total carbon dioxide(kg)

Press  Key ↓ To 1.4.1 Display Or
Press  Key 1 Sec Back to
Measurement screen

*Engineers set class, non-personnel do not arbitrarily enter the change, in order to avoid abnormal ◦

INPUT Group

Operation display

↓ Press  Key Enter the setup menus

20 12-07-03-13-50-40

KEY

in





PASS

Code

0000

Password
0000~9999

Default:1000

Press  Key: SET
 Press  Key: SHIFT
 Press  Key: MOVE/INCREASE
 Press  Key: DOWN/DECREASE
 Press  Key: CONFIRM

Energy  KEY

20 12-07-03-13-50-40

A-1

545

Y

rE

3P346

A-1 Voltage Phase line set
Set range is as follows:
1P2W/1P3W/3P3W/
3P3W.B (Balanced)/3P3W3/
3P4W/3P4W.B (Balanced)
Default:3P4W

20 12-07-03-13-50-40

A-2

pt

Pr

600

A-2 Primary-side voltage (PT)
Set range:100~500000V
Default:600

20 12-07-03-13-50-40

A-3

pt

SEC

600

A-3 Secondary-side voltage(PT)
Set range:100~600V
Default:600

20 12-07-03-13-50-40

A-4

ct

Pr

5

A-4 Primary current (CT)
Set range:5~10000A
Default:5

20 12-07-03-13-50-40

A-5

UH

VAR-H

0

A-5 Watt-h / Var Clear
ClearPasswords:
0000~9999
Code:2100

20 12-07-03-13-50-40

A-6

noFY

PLod

A-6 P.COD
Set range:
0000~9999
Default:1000

20 12-07-03-13-50-40

E-1

r485

Addr

1

Rs485 Group
E-1 Communication station No.
Set range:001~247
Default:1

20 12-07-03-13-50-40

E-2

baud

RALE

19200

E-2 Communications transmission rate
Set range:
1200、2400、4800、
9600、19200、38400
Default:9600

20 12-07-03-13-50-40

E-3

Prty

CHCE

n.8.2

E-3 Parity Check
Set range:N.8.1、
N.8.2、O.8.1、E.8.1
Default:N.8.2

20 12-07-03-13-50-40 **ENEgy Group**
F-1 Cost rates
 Set range: 00.00~99.99 (per / kWh)
 Default: 2.30

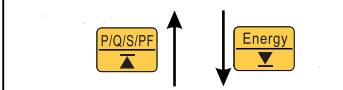

20 12-07-03-13-50-40 **F-2 CO₂ ratio**
 Set range: 0.000~9.999(kg/kWh)
 Default: 0.638



20 12-07-03-13-50-40 **TIME Group**
G-1 Backlight time
 Set range: 0~15(Minute)
 0 is always lit
 Default: 1

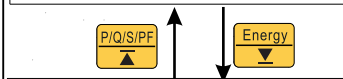

20 12-07-03-13-50-40 **G-2 Date set**
 Set range: 2000.01.01~2099.12.31



20 12-07-03-13-50-40 **G-3-Time set**
 Set range: 00.00.00~23.59.59

20 12-07-03-13-50-40 **H-1 Permanent screen selection**
 Set range: 1~4
 Schedule Description
 Default: 1



20 12-07-03-13-50-40 **I-1 INIT Restore Default**
 Set range: 0000~9999
 set: 7170
 Default: 0

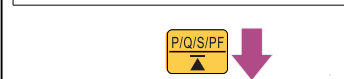

Back To A-1 Display Or
 Press Key 1 Sec Back to Measurement screen

Schedule: The Permanent screen instructions

The first
 20 12-07-03-13-50-40
 L-n
 00
 00
 00
 Avg 1000 PF
 0 kWh

1. 2. 3-phase integrated display-1
 Average Phase voltage
 Average current
 Active power
 Average power factor
 Active energy

The second
 20 12-07-03-13-50-40
 L-L
 00
 00
 00
 Avg 1000 PF
 kWh

1. 2. 3-phase integrated display-2
 Average Line voltage
 Average current
 Total Active power
 Average power factor
 Active energy

The third
 20 12-07-03-13-50-40
 3600
 00
 00
 Avg 1000 PF
 kWh

1. 2. 3-phase integrated display-3
 Total Apparent Power
 Total Reactive Power
 Total active power
 Average power factor
 Active energy

The fourth
 20 12-07-03-13-50-40
 00
 00
 00
 00
 Avg 1000 PF
 kWh

1. 2. 4-3-phase integrated display-4
 Total Apparent Power
 Total Reactive Power
 Total Active power
 Frequency
 Active energy

RS485 communication parameters address table (Function code: 03h, 06h, 10h)

General class information

Register Name	Register address	Data Format	Data Length	Measurement range	Unit	R/W	Default	Description
Frequency	0000h	XXXX	2	45.00 ~65.00	Hz /100	R		Frequency (high word)
	0001h	XX.XX						Frequency (low word)
Average phase voltage	0002h	XXXX	2	0~500000.0	V/10	R		Average phase voltage(high word)
	0003h	XXX.X						Average phase voltage(low word)
U l lavg	0004h	XXXX	2	0~500000.0	V/10	R		Average line voltage(high word)
	0005h	XXX.X						Average line voltage(low word)
I avg	0006h	XXXX	2	0~10000.000	A/1000	R		Average current(high word)
	0007h	X.XXX						Average current(low word)
In	0008h	XXXX	2	0~10000.000	A/1000	R		Neutral current(high word)
	0009h	X.XXX						Neutral current(low word)
Psum	000Ah	XXXX	2	-199999999 ~999999999	W	R		Total effective power(high word)
	000Bh	XXXX						Total effective power(low word)
Qsum	000Ch	XXXX	2	-199999999 ~999999999	VAR	R		Total reactive power(high word)
	000Dh	XXXX						Total reactive power(low word)
Ssum	000Eh	XXXX	2	-199999999 ~999999999	VA	R		Total apparent power(high word)
	000Fh	XXXX						Total apparent power(low word)
PF avg	0010h	XXXX	2	-1.000 ~1.000	PF /1000	R		Average power factor(high word)
	0011h	X.XXX						Average power factor(low word)
Ea	0012h	XXXX	2	0~99999999.9	kWh /10	R/W		Effective energy(high word) , over 99999999.9 auto Zero
	0013h	XXX.X						Effective energy(low word) , over 99999999.9 auto Zero
Er	0014h	XXXX	2	0~99999999.9	kVARh /10	R/W		Invalid electricity(high word) , over 99999999.9 auto Zero
	0015h	XXX.X						Invalid electricity(low word) , over 99999999.9 auto Zero
Cost	0016h	XXXX	2	0~99999999.9	\$/10	R		Total electricity bill(high word) , over 99999999.9 auto Zero
	0017h	XXX.X						Total electricity bill(low word) , over 99999999.9 auto Zero
CO2	0018h	XXXX	2	0~99999999.9	kg/10	R		The total carbon dioxide(high word),over 99999999.9 auto Zero
	0019h	XXX.X						The total carbon dioxide(low word),over 99999999.9 auto Zero
UA	001Ah	XXXX	2	0~500000.0	V/10	R		Phase A voltage(high word)
	001Bh	XXX.X						Phase A voltage(low word)
UB	001Ch	XXXX	2	0~500000.0	V/10	R		Phase B voltage(high word)
	001Dh	XXX.X						Phase B voltage(low word)
UC	001Eh	XXXX	2	0~500000.0	V/10	R		Phase C voltage(high word)
	001Fh	XXX.X						Phase C voltage(low word)
UAB	0020h	XXXX	2	0~500000.0	V/10	R		AB line voltage(high word)
	0021h	XXX.X						AB line voltage(low word)
UBC	0022h	XXXX	2	0~500000.0	V/10	R		BC line voltage(high word)
	0023h	XXX.X						BC line voltage(low word)
UCA	0024h	XXXX	2	0~500000.0	V/10	R		CA line voltage(high word)
	0025h	XXX.X						CA line voltage(low word)
IA	0026h	XXXX	2	0~10000.000	A/1000	R		Phase A current(high word)
	0027h	X.XXX						Phase A current(low word)
IB	0028h	XXXX	2	0~10000.000	A/1000	R		Phase B current(high word)
	0029h	X.XXX						Phase B current(low word)
IC	002Ah	XXXX	2	0~10000.000	A/1000	R		Phase C current(high word)
	002Bh	X.XXX						Phase C current(low word)
PA	002Ch	XXXX	2	-199999999 ~999999999	W	R		Phase A active power(high word)
	002Dh	XXXX						Phase A active power(low word)
PB	002Eh	XXXX	2	-199999999 ~999999999	W	R		Phase B active power(high word)
	002Fh	XXXX						Phase B active power(low word)
PC	0030h	XXXX	2	-199999999 ~999999999	W	R		Phase C active power(high word)
	0031h	XXXX						Phase C active power(low word)
QA	0032h	XXXX	2	-199999999 ~999999999	VAR	R		Phase A reactive power(high word)
	0033h	XXXX						Phase A reactive power(low word)
QB	0034h	XXXX	2	-199999999 ~999999999	VAR	R		Phase B reactive power(high word)
	0035h	XXXX						Phase B reactive power(low word)
QC	0036h	XXXX	2	-199999999 ~999999999	VAR	R		Phase C reactive power(high word)
	0037h	XXXX						Phase C reactive power(low word)
SA	0038h	XXXX	2	-199999999 ~999999999	VA	R		Phase A apparent power(high word)
	0039h	XXXX						Phase A apparent power(low word)
SB	003Ah	XXXX	2	-199999999 ~999999999	VA	R		Phase B apparent power(high word)
	003Bh	XXXX						Phase B apparent power(low word)
SC	003Ch	XXXX	2	-199999999 ~999999999	VA	R		Phase C apparent power(high word)
	003Dh	XXXX						Phase C apparent power(low word)
PFA	003Eh	XXXX	2	-1.000 ~1.000	PF/ 1000	R		Phase A Power Factor(high word)
	003Fh	X.XXX						Phase A Power Factor(low word)
PFB	0040h	XXXX	2	-1.000 ~1.000	PF/ 1000	R		Phase B Power Factor(high word)
	0041h	X.XXX						Phase B Power Factor(low word)
PFC	0042h	XXXX	2	-1.000 ~1.000	PF/ 1000	R		Phase C Power Factor(high word)
	0043h	X.XXX						Phase C Power Factor(low word)
LT	0044h	XX	1	82=R, 76=L, 67=C		R		R:Resistive, L:Inductive , C:Capacitive

General class information

Register Name	Register address	Data Format	Data Length	Measurement range	Unit	R / W	Default	Description
THDUA	0045h	XXX.X	1	0~100.0	%/10	R		Phase A voltage total harmonic(3P3W,THDUAB)
THDUB	0046h	XXX.X	1	0~100.0	%/10	R		Phase B voltage total harmonic(3P3W,THDUBC)
THDUC	0047h	XXX.X	1	0~100.0	%/10	R		Phase C voltage total harmonic(3P3W,THDUCA)
THDUavg	0048h	XXX.X	1	0~100.0	%/10	R		Average voltage total harmonic
THDIA	0049h	XXX.X	1	0~100.0	%/10	R		Phase A current total harmonic
THDIB	004Ah	XXX.X	1	0~100.0	%/10	R		Phase B current total harmonic
THDIC	004Bh	XXX.X	1	0~100.0	%/10	R		Phase C current total harmonic
THDIavg	004Ch	XXX.X	1	0~100.0	%/10	R		Average total harmonic current

Input group setting class

Register Name	Register address	Data Format	Data Length	Measurement range	Unit	R / W	Default	Description
Voltage wiring Wire-U	004Dh	X	1	0~6		R/W	5	0:1P2W 1:1P3W 2:3P3W 3:3P3W.B 4:3P3W.3 5:3P4W 6:3P4W.B
PT-Pri	004Eh	XXXX	2	100~500000	V	R/W	600	PT Primary side voltage setting(high word)
	004Fh	XXXX						PT Primary side voltage setting(low word)
PT-Sec	0050h	XXXX	1	100~600	V	R/W	600	PT Secondary voltage settings
CT-Pri	0051h	XXXXX	1	1~10000	A	R/W	5	CT Primary current setting
P.code	0052h	XXXX	1	0000~9999		R/W	1000	Clearance password change

RS485 communication group settings class

Register Name	Register address	Data Format	Data Length	Measurement range	Unit	R / W	Default	Description
Addr	0053h	XXX	1	1~247		R/W	1	The Communication Station No. setting
Baud	0054h	X	1	0~5		R/W	3	0:1200 , 1:2400 , 2:4800 , 3:9600 , 4:19200 , 5:38400
Parity	0055h	X	1	0~3		R/W	1	0:N81 , 1:N82 , 2:O81 , 3:E81

Cost group setting class

Register Name	Register address	Data Format	Data Length	Measurement range	Unit	R / W	Default	Description
Cost	0056h	XX.XX	1	00.00~99.99		R/W	2.30	kWh the cost ratio setting
CO2	0057h	X.XXX	1	0.000~9.999		R/W	0.638	kWh of CO2 ratio setting

Time group settings class

Register Name	Register address	Data Format	Data Length	Measurement range	Unit	R/W	Default	Description
Back-Light	0058h	XX	1	0~15		R/W	1	0~15Minute, 0 is Steadily lit
Year	0059h	XX	1	0~99		R/W		0~99 = 2000~2099
Month	005Ah	XX	1	1~12		R/W		
Day	005Bh	XX	1	1~31		R/W		
Time	005Ch	XX	1	0~23		R/W		
Minute	005Dh	XX	1	0~59		R/W		
Second	005Eh	XX	1	0~59		R/W		

Permanent screen group settings class

Register Name	Register address	Data Format	Data Length	Measurement range	Unit	R/W	Default	Description
Def.Page	005Fh	X	1	1~4		R/W	1	1: V-N / A / P / PF / kWh 2: V-L / A / P / PF / kWh 3: S / Q / P / PF / kWh 4: S / Q / P / F / kWh

Register Name	Register address	Data Format	Data Length	Measurement range	Unit	R/W	Default	Information
INIT	0060h	XXXX	2	0000~9999		R/W	0	Set:7170,Restore Default

Client Custom class

Register Name	Register address	Data Format	Data Length	Measurement/Set Range	Unit	R/W	Default	Description
Client Custom 1	5000h	XX	1	0~76(0x4c)		R/W	0x0000h	This regional data to set the following 20 addresses (5014h~5027h) content of the information, That is redefining 5014h~5027h address information significance Address correspondence to: 5000h set 5014h corresponding address data content. Address correspondence to: 5001h set 5015h corresponding address data content. Address correspondence to: 5013h set 5027h address data corresponding to content. Example: 1: 5000h address data = 0000h, 5001h address data = 0001h. Then the corresponding address 5014h ,5015h addresses are mapped to the content of 0000h, 0001h, according to the table, 5014h ,5015h address data for the frequency content high byte and low byte (Setting range 0 ~ 0x4c, read the corresponding region RS485 Data Sheet)
Client Custom 2	5001h	XX	1	0~76(0x4c)		R/W	0x0001h	
Client Custom 3	5002h	XX	1	0~76(0x4c)		R/W	0x0002h	
Client Custom 4	5003h	XX	1	0~76(0x4c)		R/W	0x0003h	
Client Custom 5	5004h	XX	1	0~76(0x4c)		R/W	0x0004h	
Client Custom 6	5005h	XX	1	0~76(0x4c)		R/W	0x0005h	
Client Custom 7	5006h	XX	1	0~76(0x4c)		R/W	0x0006h	
Client Custom 8	5007h	XX	1	0~76(0x4c)		R/W	0x0007h	
Client Custom 9	5008h	XX	1	0~76(0x4c)		R/W	0x0008h	
Client Custom 10	5009h	XX	1	0~76(0x4c)		R/W	0x0009h	
Client Custom 11	500Ah	XX	1	0~76(0x4c)		R/W	0x000Ah	
Client Custom 12	500Bh	XX	1	0~76(0x4c)		R/W	0x000Bh	
Client Custom 13	500Ch	XX	1	0~76(0x4c)		R/W	0x000Ch	
Client Custom 14	500Dh	XX	1	0~76(0x4c)		R/W	0x000Dh	
Client Custom 15	500Eh	XX	1	0~76(0x4c)		R/W	0x000Eh	
Client Custom 16	500Fh	XX	1	0~76(0x4c)		R/W	0x000Fh	
Client Custom 17	5010h	XX	1	0~76(0x4c)		R/W	0x0010h	
Client Custom 18	5011h	XX	1	0~76(0x4c)		R/W	0x0011h	
Client Custom 19	5012h	XX	1	0~76(0x4c)		R/W	0x0012h	
Client Custom 20	5013h	XX	1	0~76(0x4c)		R/W	0x0013h	
Custom the output 1	5014h		1			R		Meaning of the data subject 5000h~5013h address control, data format and the unit and the actual output data format to match the format, see the table RS485
Custom the output 2	5015h		1			R		
Custom the output 3	5016h		1			R		
Custom the output 4	5017h		1			R		
Custom the output 5	5018h		1			R		
Custom the output 6	5019h		1			R		
Custom the output 7	501Ah		1			R		
Custom the output 8	501Bh		1			R		
Custom the output 9	501Ch		1			R		
Custom the output 10	501Dh		1			R		
Custom the output 11	501Eh		1			R		
Custom the output 12	501Fh		1			R		
Custom the output 13	5020h		1			R		
Custom the output 14	5021h		1			R		
Custom the output 15	5022h		1			R		
Custom the output 16	5023h		1			R		
Custom the output 17	5024h		1			R		
Custom the output 18	5025h		1			R		
Custom the output 19	5026h		1			R		
Custom the output 20	5027h		1			R		