

CM1-VA ECONOMIC VOLT/CURRENT Meter

DESCRIPTION

CM1 series Indicator has been designed in simple function and 4 digital 20.0mm LED displays with economic cost.

They can be programmed by tack switches that are hidden in backside of front bezel.

They are also available 1 option of 2 Relay outputs, 1 Analogue output or 1 RS485(Modbus RTU Mode) interface with versatile functions such as control, alarm, re-transmission or communication for a wide range of industrial applications.



FEATURE

- Measuring AC / DC Voltage 0~50.00mV/~600.0V / Current 0~1.999mA/~10.00A
- Optional output available for one of 2 relay, analogue or RS485
- CE Approved & RoHS

APPLICATIONS

- Testing Equipments for Volt/Current Measuring,
- MCC panel, Machinery, Switch gear... for Voltage or Current Measuring

ORDERING INFORMATION

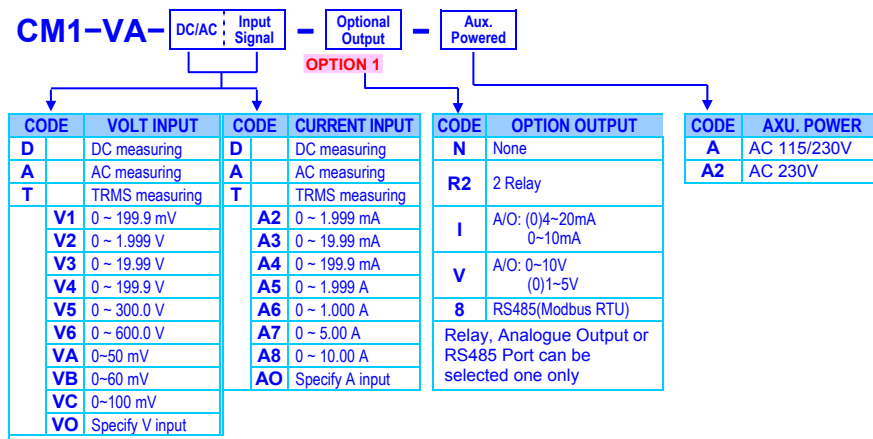

TECHNICAL SPECIFICATION

Measuring Range DC / AC		Input Impedance	Measuring Range DC / AC		Input Impedance
Voltage	0~50/~100 mV	≥5M ohm	Current	0~1.999 mA	100 ohm
	0~199.9 mV	≥5M ohm		0~19.99 mA	10 ohm
	0~1.999 V	≥1M ohm		0~199.9 mA	1 ohm
	0~19.99 V	≥1M ohm		0~1.999 A	0.05 ohm
	0~199.9 V	≥1M ohm		0~5.000 A	0.02 ohm
	0~300.0 V	≥2M ohm		0~10.00 A	0.01 ohm
0~600.0 V	≥2M ohm				

Calibration: Digital calibration by front key
A/D converter: 12 bits resolution
Accuracy: DC: $\leq \pm 0.1\%$ of FS $\pm 1C$
 AC: $\leq \pm 0.2\%$ of FS $\pm 1C$
Sampling rate: 15 cycles/sec
Response time: ≤ 100 msec.(when the AvG = "1") in standard

Display & Functions

LED: Numeric: 4 digits, 0.8"(20.0mm) red high-brightness LED
Display range: -1999~+9999
Scaling function: L α SC : Low Scale; Settable range: -1999~+9999
 H α SC : High Scale; Settable range: -1999~+9999
 Programmable from 0 / 00 / 000 / 0000
Over range Indication: o α FL, when input is over 110% of input range Hi
Under range indication: -o α FL, when input is under -0% of input range Lo
Max / Mini recording: Maximum and Minimum value storage during power on.
Low cut: L α CUt : Settable range: -1999~9999 counts

Reading Stable Function

Average: R α U Settable range: 1~99 times
Moving average: \bar{R} α U Settable range: 1~99 times
Digital filter: dF α Lt Settable range: 1~99 times

Control Functions(option)

Set-points: Two set-point
Control relay: 2 Relay, FORM-C, 5A/230Vac, 10A/115V
Relay energized mode: Energized levels compare with set-points:
 Hi / Lo / Hi.HLd / Lo.HLd programmable
Energizing functions: Start delay / Energized & De-energized delay / Hysteresis
 Energized Latch
Start band(Minimum level for Energizing): 0~9999counts
Start delay time: 0:00.0~9(Minutes):59.9(Second)
Energized delay time: 0:00.0~9(Minutes):59.9(Second)
De-energized delay time: 0:00.0~9(Minutes):59.9(Second)
Hysteresis: 0~5000 counts

Analogue output(option)

Accuracy: $\leq \pm 0.2\%$ of F.S. ; 12 bits DA converter
Ripple: $\leq \pm 0.1\%$ of F.S.
Response time: ≤ 100 msec. (10~90% of input)
Isolation: AC 2.0 KV between input and output
Output range: Specify either Voltage or Current output in ordering
Voltage: 0~5V / 0~10V / 1~5V programmable
Current: 0~10mA / 0~20mA / 4~20mA programmable
Voltage: 0~10V: $\geq 1000\Omega$;
Current: 4(0)~20mA: $\leq 600\Omega$ max
Functions: R α HS (output range high): Settable range: -1999~9999
 R α LS (output range Low): Settable range: -1999~9999
Digital fine adjust: R α P α o : Settable range: -1999~9999
 R α SPn : Settable range: -1999~9999

RS 485 Communication(option)

Protocol: Modbus RTU mode
Baud rate: 1200/2400/4800/9600/19200/38400 programmable
Data bits: 8 bits
Parity: Even, odd or none (with 1 or 2 stop bit) programmable
Address: 1 ~ 255 programmable
Distance: 1200M
Terminate resistor: 150Ω at last unit.

Power

Power supply: AC115/230V±15%,50/60Hz;
Power consumption: 3.0VA maximum
Back up memory: By EEPROM

Electrical Safety

Dielectric strength: AC 2.0 KV for 1 min, Between Power / Input / Output / Case
Insulation resistance: ≥100M ohm at 500Vdc, Between Power / Input / Output
Isolation: Between Power / Input / Relay, Analogue or RS485
EMC: EN 55011:2002; EN 61326:2003
Safety(LVD): EN 61010-1:2001

Environmental

Operating temp.: 0~60 °C
Operating humidity: 20~95 %RH, Non-condensing
Temp. coefficient: ≤100 PPM/°C
Storage temp.: -10~70 °C
Enclosure: Front panel: IEC 529 (IP52); Housing: IP20

Mechanical

Dimensions: 96mm(W) x 48mm(H) x 72mm(D)
Panel cutout: 93mm(W) x 45mm(H)
Case material: ABS fire-resistance (UL 94V-0)
Mounting: Panel flush mounting
Terminal block: Plastic NYLON 66 (UL 94V-0)
 20A/300Vac, M3.5, 22~12AWG
Weight: 310g

■ DIMENSIONS

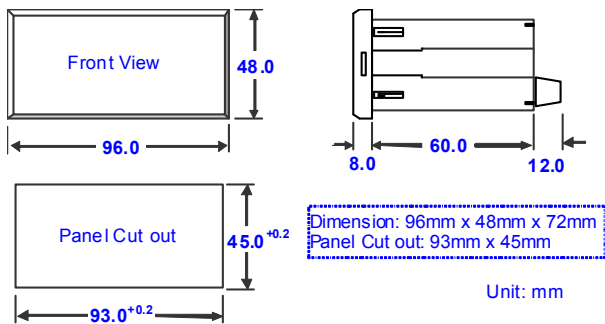

■ INSTALLATION

The meter should be installed in a location that dose not exceed the maximum operating temperature and provides good air circulation.

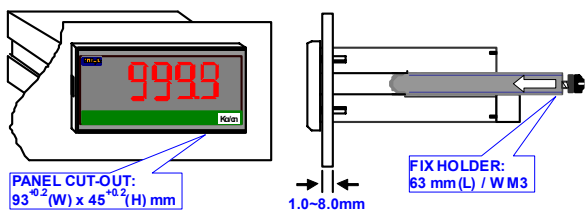

■ CONNECTION DIAGRAM

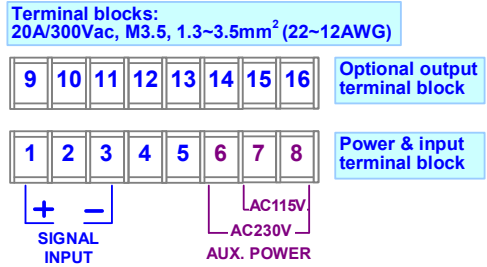

Power and Input

Please check the voltage of power supplied first, and then connect to the specified terminals. It is recommended that power supplied to the meter be protected by a fuse or circuit breaker.

Power Supply

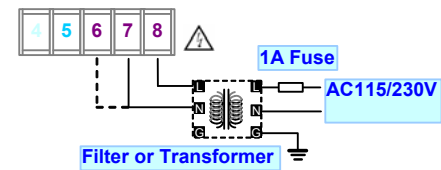

CM1-VA Input connection

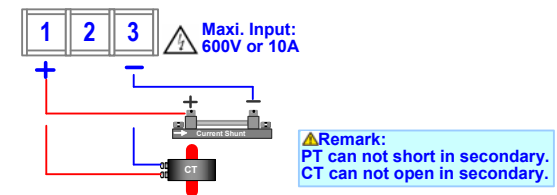

Output (one output available of Relay, Analogue or RS485)

Relay output

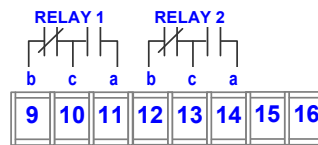

Analogue output

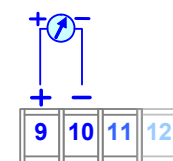

RS485 port

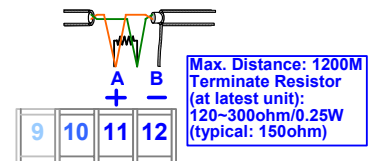

■ FUNCTION DESCRIPTION

Scaling function:

Setting the [L_oSC] (Low scale) and [H_oSC] (High scale) in [INPUT GROUP] to relative input signal. Reverse scaling will be done too. Please refer to the figure as below,

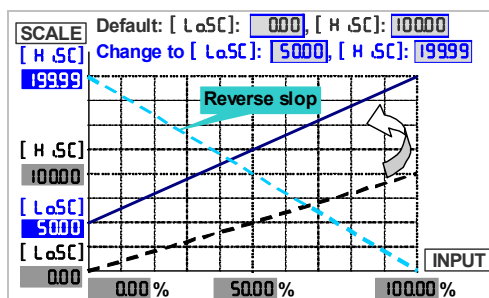

*Too narrow scale may course display lower resolution.

Display & Functions

Max / Mini recording: The meter will storage the maximum and minimum value in [user level] during power on in order to review drifting of PV.

Reset for Max(Mini) Hold [r5t]:
The maximum and minimum recording can be reset by [r5t] in [user level] .

Low cut:

If the setting value is positive, it means when the absolutely value of PV ≤ Setting value, the display will be the setting of [Lo5C]. If the setting value is negative, it means when the PV under setting value (PV ≤ -Setting value), the display will be setting value of [Lo5C].

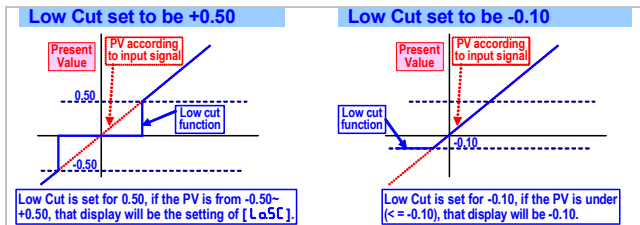

Reading Stable Function

Average:

Basically, the sampling rate of meter is 15cycles/sec. If the function set to be 3 times, It means the meter will update of display will be 5 times/sec.

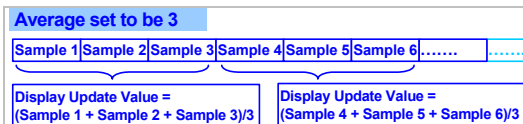

Remark: The higher average setting will cause the response time of Relay and Analogue output slower.

Moving average:

If the function to be set 3 times, the meter will update delay in first 3 samples, then it will update 15 times/sec continuously.

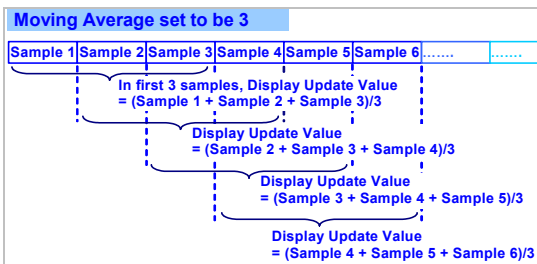

Remark: The higher moving average setting wouldn't cause the response time of Relay and Analogue output slower after first 3 samples.

Digital filter: The digital filter can reduce the magnetic noise in field.

Control functions(option)

Relay energized mode: Hi / Lo / Hi.HLd / Lo.HLd programmable
Hi [H](Fig.1-①): Relay will energize when PV > Set-Point
Lo [L](Fig.1-②): Relay will energize when PV < Set-Point

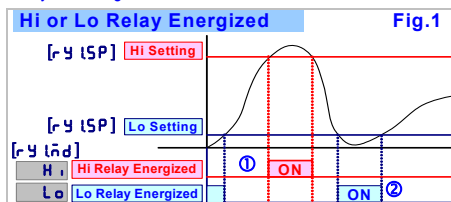

Energized functions: Start delay / Energized & De-energized delay / Hysteresis

Start delay band and Start delay time:

- The functions have been designed for,
 - ▶ To avoid starting current of inductive motor (6 times of rated current) with alarm.
 - ▶ If the [r5rd] relay energized mode had been set to be [Lo] (Lo). As the meter is power on and no input to display the "0" caused the relay will be energized. User can set a band and delay time to inhibit the energized of relay.

Start band [r5b] (Fig.2-①): Settable range from 0~9999 Counts
Start delay time [r5d] (Fig.2-②): Settable range from 0.0(s)~9(m)59.9(s);

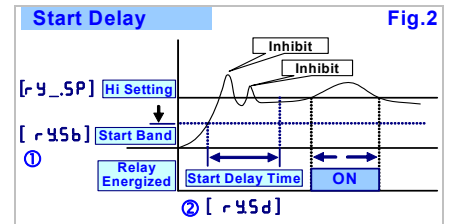

Hysteresis [r5hy] (Fig.3-①): Settable range from 0~5000 Counts

As the display value is swing near by the set point to cause the relay on and off frequently. The function is to avoid the relay on and off frequently such as compressor.....etc.,

Relay energized delay [r5rd] (Fig.3-②): Settable range from 0.0(s)~9(m)59.9(s);

The function is to avoid the miss action caused by noise. Sometime, the display value will swing caused by spark of contactor...etc.. User can set a period to delay the relay energized.

Relay de-energized delay [r5fd] (Fig.3-③): Settable range from 0.0(s)~9(m)59.9(s);

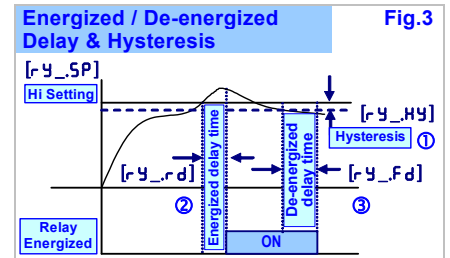

Analogue output(option)

Please specify the output type either an 0~10V or 4(0)~20mA in ordering. The programmable output low and high scaling can be based on various display values. Reverse slope output is possible by reversing point positions.

Output range: Voltage: 0~5V / 0~10V / 1~5V programmable
Current: 0~10mA / 0~20mA / 4~20mA programmable

Functions:

- Output range high** [RaHS]: Setting the Display value High to versus output range High(as like as 20mA in 4~20)
- Output range low** [RaLS]: Setting the Display value Low to versus output range Low(as like as 4mA in 4~20)

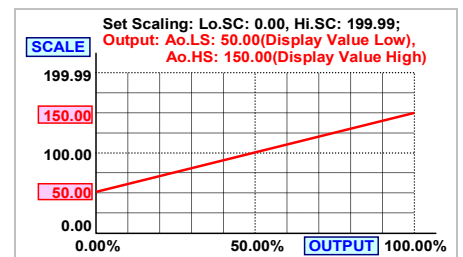

The range between RaHS and RaLS should be over 20% of span at least; otherwise, it will be got less resolution of analogue output.

Fine zero & span adjustment:

Users can get Fine Adjustment of analogue output by front key of the meter. Please connect standard meter to the terminal of analogue output. To press the front key (up or down key) of meter to adjust and check the output.

Zero adjust [RaZr]: Fine Zero Adjustment for Analog Output; Settable range: -1999~9999;

Span adjust [RaSp]: Fine Span Adjustment for Analog Output; Settable range: -1999~9999;

RS 485 Communication(option)

The RS485's protocol is Modbus RTU mode, and baud rate up to 38400 bps. It's convenience to remote monitoring, display for reading.

OPERATING KEY

*Please access to the Programming Level to check and set the parameters when users start to run the meter

- Operating Key:** 4 keys for Enter(Function) / Shift(Escape) / Up key / Down key
- The meter has designed operation similar as PC's and . In any page, press key means "enter" or "confirm setting", and press key means "escape()" or "shift".
- In Programming Level, the screen will return to Measuring Page after do not press any key over 2 minutes, or press for 1 second.

	Function Index	Setting Status
(= / Enter/Fun key	(1) In any page, press to access the level or function index (2) From the function index to access setting status	(3) Setting Confirmed, save to EEPROM and go to next function index
(= Shift key	(1) In measuring page, press for 1 second to access user level. (2) In function index, press for 1 second to go back upper level. (3) In function group index, press for 1 second to go back measuring page	(4) In setting status, press to Shift the setting position. (5) In setting status, press for 1 second to abort setting and go back this function index.
(= Up key	(1) In function index, press to go back to previous function index	(2) In setting status for function, press to select function (3) During number Setting, press can roll the digit up
(= Down key	(1) In Function Index Page, press will go to the next Function Index Page.	(2) In setting status for function, press to select function (3) During number Setting, press can roll the digit down.

FRONT PANEL

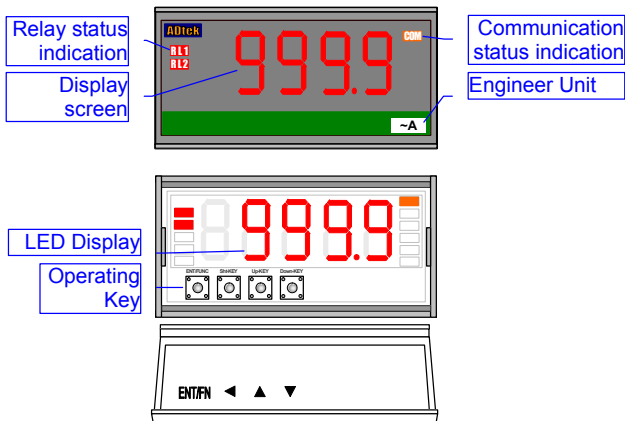

Stickers:

Each meter has a sticker for engineer units.

~μA	~mA	~A	~KA	=μA	=mA	=A	=KA		
~μV	~mV	~V	~KV	=μV	=mV	=V	=KV		
A hr	A min	A sec	A rms	V rms	A/mA	W/A	Var/A		
W	KW	MW	WH	KWH	MWH	W/WH	W/Var		
Var	KVar	MVar	QH	KQH	MQH	COS θ	Var/VarH		
VA	KVA	MVA	VAH	KVAH	MVAH	θ	KVarH		
Hz	PF	KA	KV	KHz	MVarH	KM/hr			
A	mA	V	mV	Ω	K Ω	$^{\circ}$ C	$^{\circ}$ F	%RH	
RPM	M/min	Y/min	F/min	M/sec	%	$^{\circ}$	M Ω		
Kg/cm 3	Bar	mmH $_2$ O	mmHg	KPA	mmAq	PSI	mBar	PA	
M 3 /min	ml/min	Ton/D	L/min	Torr	M 3 /hr	Kg-cm	cmHg		
mm	cm	M	KM	ft	Yard	ppm	ppb	C.C	
g	KG	Ton	T-cm	NT-cm	PH	MPM	L		

- Operating Key:** 4 keys for Enter(Function) / Shift(Escape) / Up key / Down key
- Pass Word:** Settable range:0000~9999;
User has to key in the right pass word so that get into [Programming level]. Otherwise, the meter will go back to measuring page. If user forgets the password, please contact with the service window.

Number screen

0.8"(20.0mm) red high-brightness LED for 5 digital present value.

I/O Status Indication

- Relay Energized:** 2 square red LED
 display when Relay 1 energized;
 display when Relay 2 energized;
- RS485 Communication:** 1 square orange LED
 will flash when the meter is receive or send data, and flash quickly means the data transient quicker.

OPERATING DIAGRAM (The detail description of operation, please refer to operating manual.)

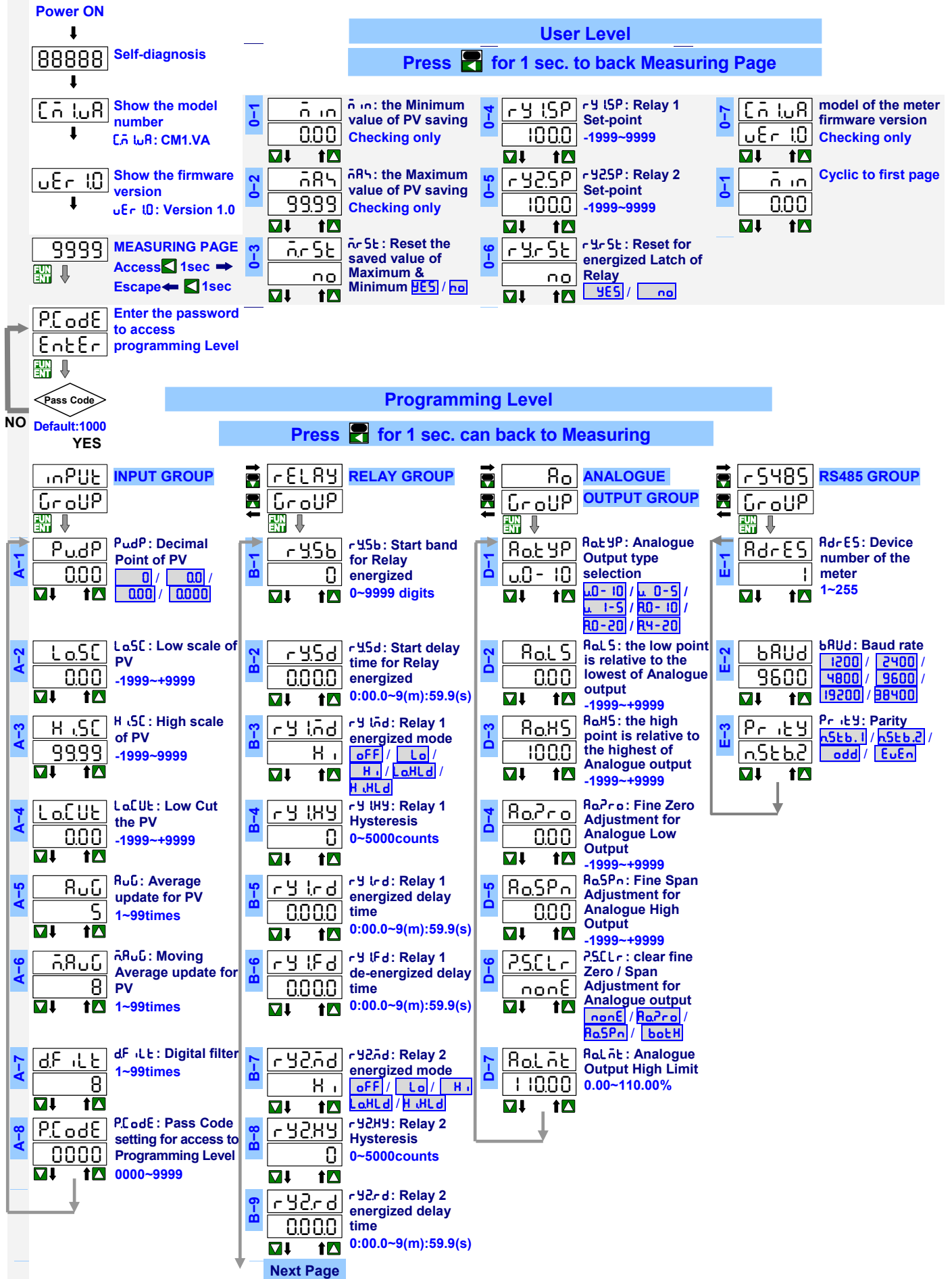

B-10

rY2Fd	rY2Fd: Relay 2
0000	de-energized delay
	time
	0:00.0~9(m):59.9(s)

↑ ↓

↓

Please refer to operating manual for detail description