

# MULTI-CHANNEL EDDY CURRENT FLAW DETECTOR EDDYCON D

  
Member company of  
«OKO ASSOCIATION»  
Group

## THE BEST INDUSTRIAL OEM SOLUTION FOR IN-LINE AND IN-SERVICE SYSTEMS



[www.oko-ndt.com](http://www.oko-ndt.com)

## PURPOSE

The EDDYCON D universal multi-channel eddy current flaw detector is designed to solve a wide range of tasks of eddy current flaw detection in such industries as:

- **AIRCRAFT** - testing of aeronautical engineering parts (wheel disks, covering, turbine blades, multilayered constructions, holes of various kinds, etc.);
- **OIL-AND-GAS** - testing of pipelines, turbine blades of gas-distributing station (GDS), pressure vessels, etc.;
- **CHEMICAL** - testing of pipelines, industrial tanks, etc.;
- **POWER** - testing of steam generator pipes by inner bobbin eddy current probes, collectors, etc.;
- **MACHINE BUILDING** - testing of rods, wire, metalwares, forming rolls, sheet metals, etc.;
- **RAIL TRANSPORT** - testing of rail components and car units (parts of wheel pair and axlebox unit, load trolley, refrigerated carriages and coaches, automatic coupler, etc.).

The flaw detector is an eddy current channel that using the Ethernet port is connected to stationary PCs, portable laptops or tablets and using specially configured software creates high-performance systems for non-destructive testing.

## THE FLAW DETECTOR ADVANTAGES AND DISTINCTIVE FEATURES

- High performance due to the flaw detector multi-channeling;
- Capability to combine several EC channels when creating the automated testing systems;
- High frequency measurement;
- Ethernet port for two-way communication with PC;
- Data transmission via Wi-Fi channel;
- Rotary scanners connection;
- Up to 2 encoders connection;
- Availability of multi-functional software for flaw detection of various test objects (testing the pipe body, rolled products, wheelsets, rails, bars, wires, etc).

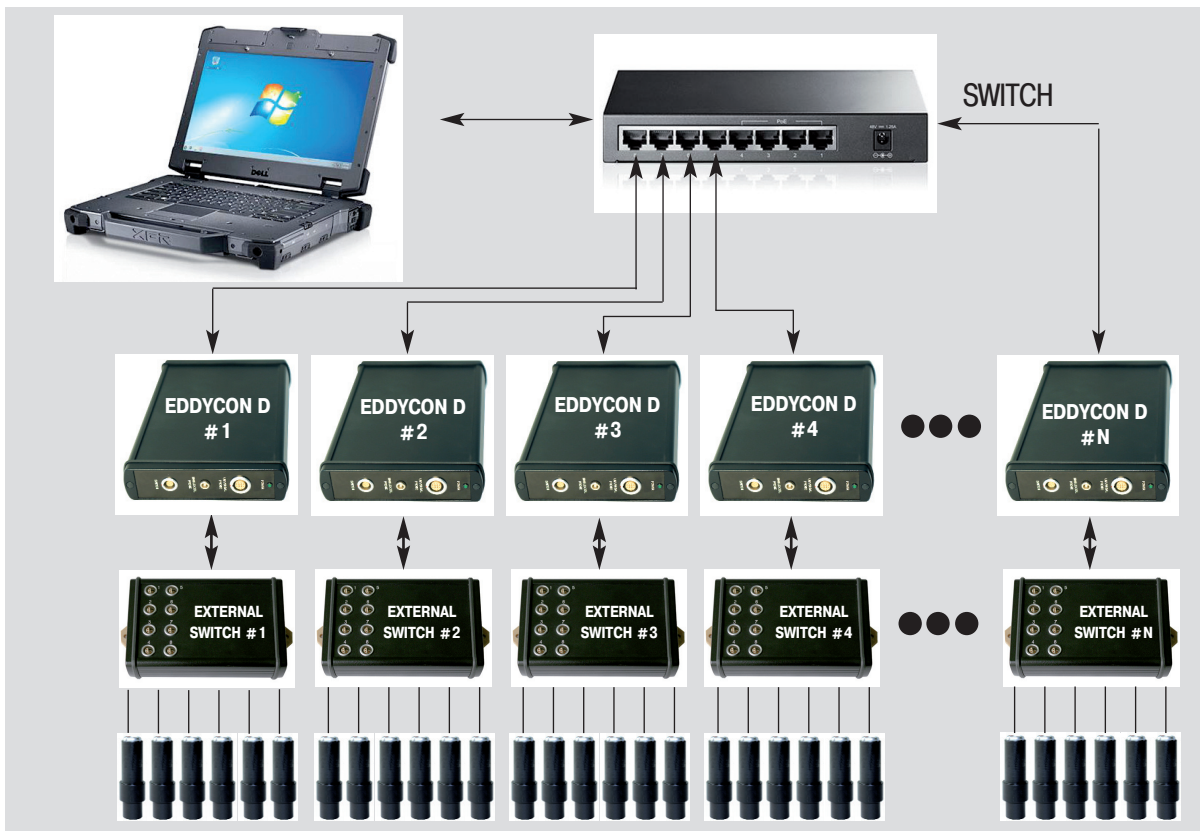

Figure 1. Scheme for constructing the multi-channel system

## THE INSTRUMENT SPECIFICATIONS AND SERVICE FUNCTIONS

- Operating frequency setup range-from 10 Hz to 16 MHz;
- Generator output voltage (double amplitude) – from 0.5 V to 20 V;
- Adjusted gain range \_\_\_\_\_ 70 dB;
- "Added gain" function \_\_\_\_\_ 30 dB;
- Digital filtering, 3 filter types: Low-pass, High-pass, Bandpass;
- Availability to connect a large number of ECPs when using external switches on 8, 16, 32, 64 or 128 channels due to the multiplexing of a first physical channel;
- Connection of up to 128 ECPs to one eddy current channel;
- External synchronization;
- Capability to connect and operate with the following ECPs:
  - differential ECP;
  - differential ECP connected according to the bridge scheme;
  - differential ECP of transformer type with grounded centerpoint;
  - differential ECP of transformer type;
  - absolute (parametric) ECP;
  - absolute ECP of transformer type;
- Setting up time for the flaw detector operation – not more than 1 minute;

## SPECIALY CONFIGURED SOFTWARE

Specially configured software for operation with the EDDYCON D eddy current channel includes:

- Program manager;
- Program for setting up the EC channel;
- Program of testing;
- Program for reviewing the testing results.

### Program for setting up the EC channel

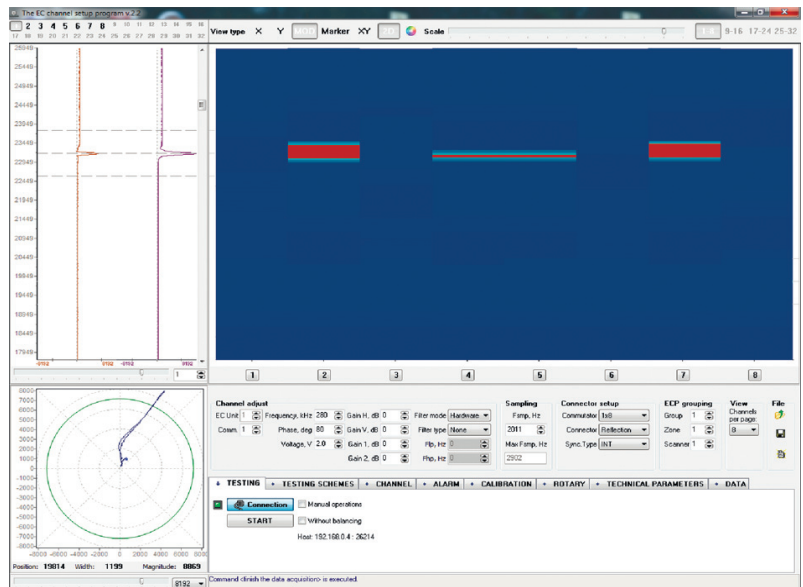

Interface example of a program for setting-up the EC channel

- This software ensures the following:
- Creation of settings with unique names for different test objects (such as bars, pipes, rails, plates, etc.);
  - Rapid set up of all EC channel parameters:
    - EC probe frequency, generator output voltage, gain, filters, threshold level type, encoder, etc.
  - Estimating the defect depth and length;
  - Four independent threshold levels for automated defect triggering (ALARM) for each displayed area;
  - Saving the testing setups into the PC or tablet's memory;
  - Channels mix.



## Program of testing

Interface example of a program of testing

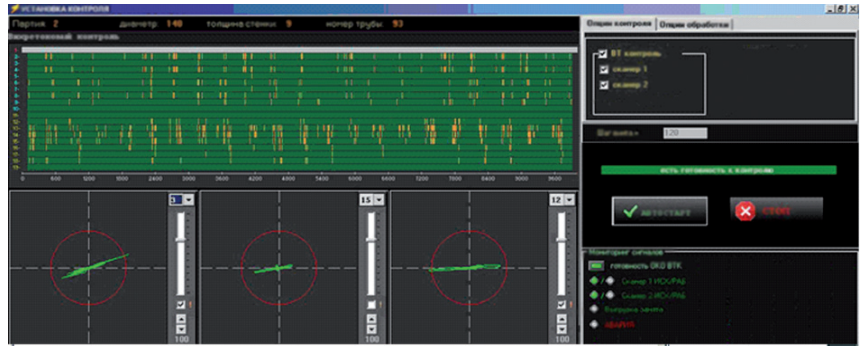

- This software ensures the following:
  - EC probes per channel display;
  - Real-time display of EC probe information (time charts, complex plane, two-dimensional display);
  - Recording the testing results into the PC or tablet memory;
- Displaying the status of mechanisms and units on the mnemonic scheme;
- Testing process control, shop mechanization (when designing automated NDT systems).

4

## Program for reviewing the testing results

Interface example of a program for reviewing the testing results

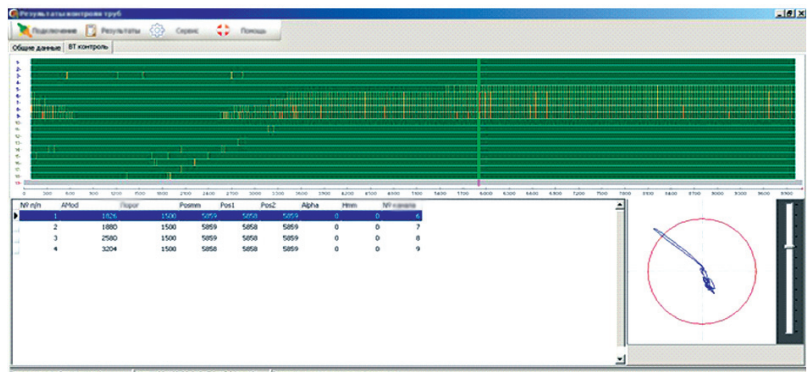

- This software ensures the following:
  - Reviewing the testing results from the database, sorting and retrieval by various characteristics;
- Generating the testing protocols;
- Archiving the testing results;
- Reviewing the testing results from the remote PC, etc.

## THE EDDYCON D MAIN SPECIFICATIONS

Parameter	Value	Parameter	Value
• Overall dimensions _____ not more than 293 x 37 x 141 mm;		<b>INPUTS/OUTPUTS</b>	
• Weight _____ not more than 1 kg;		• Ethernet _____ available;	
• Number of EC probes connected to one EC channel _____ not less than 128;		• Synchronous input _____ available;	
• ECP connectors _____ Lemo 12, Lemo 00;		• Encoder output _____ 1- axis Encoder line;	
• Power _____ 12 V DC power;		<b>RECEIVER</b>	
• Time for operating mode setup _____ up to 1 min;		• Gain _____ from 0 to 70 dB with a step 1, 10 dB	
• Warranty _____ 1 year.		• Input signal _____ not more than 0.5 V from Peak to Peak	
<b>GENERATOR</b>		• Digital filters _____ High-frequency, Low-frequency, Bandpass	
• Output voltage (double amplitude) _____ 0,5 - 20 V, Peak-Peak;		<b>MAIN METROLOGICAL SPECIFICATIONS</b>	
• Frequency range _____ from 10 Hz to 16 MHz;		• Protection level _____ IP 64;	
• Synchronization type _____ internal, from encoder, from rotary ECP		• Environment humidity _____ from - 10° to +45 °C;	
		• Atmospheric pressure _____ from 84 to 106,7 kPa;	
		• Atmospheric pressure _____ (93 ± 3) % at 25 °C;	
		• Full average life of the flaw detector _____ not less than 10 years;	

## IMPLEMENTED CONFIGURATIONS

By designing special-purpose scanners, as well as including the EDDYCON D channel as a part of automated NDT systems makes it possible more effectively to solve the flaw detection tasks for various metal parts and units in different industries.

### Mechanized and automated eddy current testing of rails and profiled bars

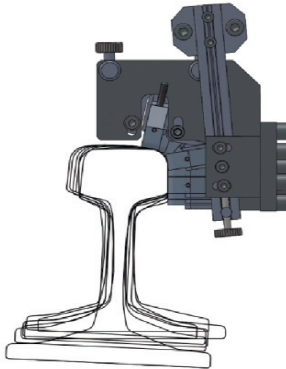
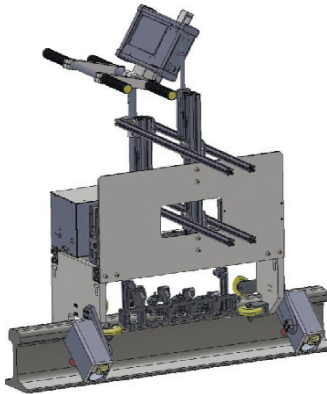

Testing of linearly extended objects with simple or complicated configuration for the presence of surface flaws.

Eddycon D flaw detector allows arranging a high-speed industrial communication between individual test positions, scanning units and server station via Wi-Fi channel.

The photo shows a mechanized scanner equipped with Eddycon D eddy-current multichannel flaw detectors for 100% eddy-current testing of rail foot, head and side surfaces in accordance with DIN EN 13674-1, and STO RZhd 1.11.2009.

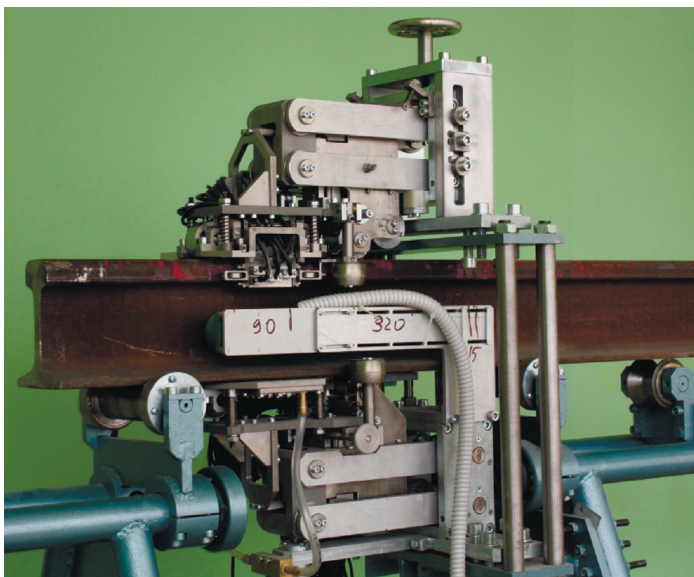
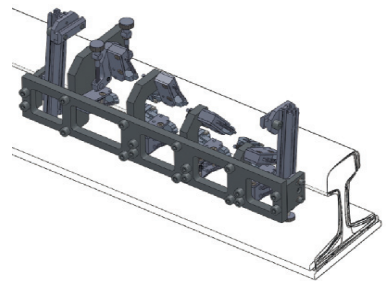

Building of automated eddy-current system for rails testing equipped with Eddycon D multichannel flaw detectors into a production line allows to avoid the necessity of "balancing" on each rail to be tested, due to the possibility of saving the balancing parameters on the calibration block.

Eddycon D flaw detector allows to perform highly-efficient testing of rails in accordance with DIN EN 13674-1, and STO RZRD 1.11.2009 with the speed of up to 2 m/s, providing for 100% testing of rolling surface, side edges and rail foot.



• Automated testing of pipes and round bars

Construction of multichannel systems for implementing the technology of 100% eddy-current testing of pipe body when progressively rotated, as well as for simultaneous detection of longitudinal and transverse flaws.

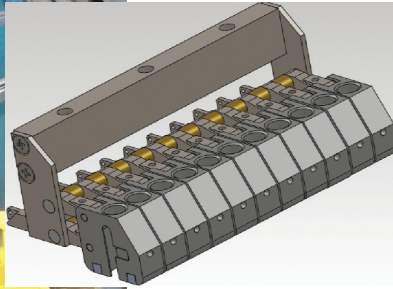
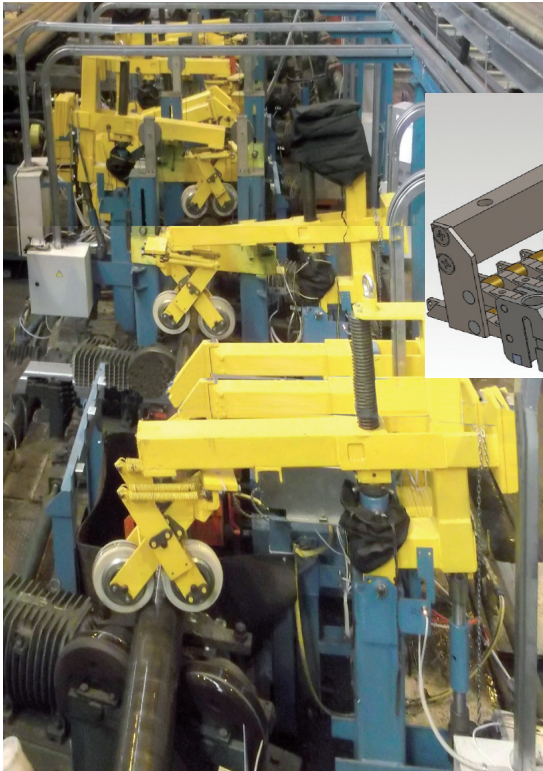

The use of Eddycon D multichannel flaw detectors allows:

- to implement high-performance multichannel systems;
- to ensure an easy integration into the existing production line;
- to guarantee 100% eddy-current testing, with automatic recording the defect areas and saving the test results.

The photo above shows SNK T-18 VT automated system equipped with Eddycon D multichannel eddy-current flaw detectors. The system is able to test up to 30 pipes per hour, with outer diameter of 245 mm, and to detect flaws in accordance with the requirements of API Spec 5L, DIN EN ISO 10893-1, DIN EN ISO 10893-2, ASTM E571-12, etc.

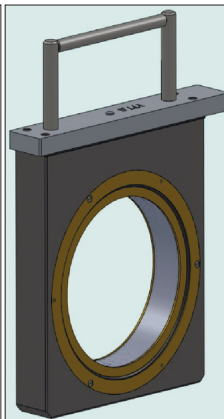
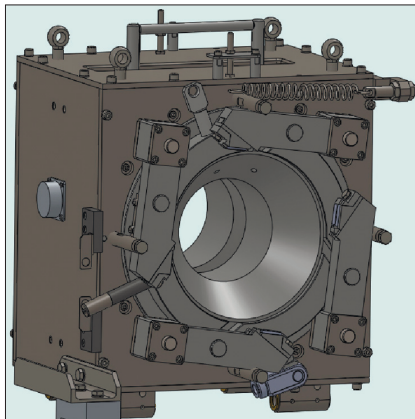

Budget systems for implementing the technology of eddy-current testing of linearly moving objects.

Testing of pipes, bars, wires using the encircling external ECPs for detection of unacceptable surface flaws.

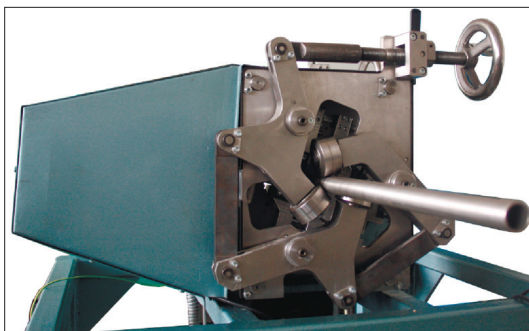
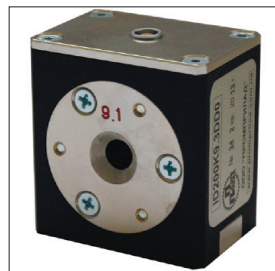

High-frequency measurement provided by Eddycon D flaw detector allows to design high-speed rotary systems for pipes and bars testing, using the rotary ECPs for detection of unacceptable surface flaws.







**PROMPRYLAD LLC, a subsidiary of «OKO ASSOCIATION» Group**  
**P.O.Box 43, Kiev 04080, Ukraine, tel.+38 044 594-52-55**  
**E-mail:global-sales@oko-ndt.com [www.oko-ndt.com](http://www.oko-ndt.com)**