



CATALOGUE

PORTABLE TEST AND MEASUREMENT INSTRUMENTS



About the CHAUVIN ARNOUX GROUP

Founded in Paris, France in 1893, **CHAUVIN ARNOUX** has spent the centuries since then developing its expertise in the design, manufacture and marketing of measuring instruments for professionals.

From handheld instrumentation to fixed electrical equipment and energy performance systems, and from control of the entire thermal process chain to industrial metrology, the **CHAUVIN ARNOUX** Group's offering meets every customer requirement across all the sectors (self-employed electricians, industry, government bodies, etc.).

“ CHAUVIN ARNOUX is a major player in the measurement market in France and internationally. ”

Your partner:

- energy performance
- regulatory testing
- environmental measurements
- installation supervision and sizing.

A Few Figures

- 10 subsidiaries worldwide
- 900 employees
- 6 production sites
- 6 R&D departments worldwide
- 11% of revenues invested in R&D
- Turnover of 100 million euros



Made in France
The French family company Chauvin Arnoux designs and manufactures 80 % of its products in the R&D Centres and production sites owned by the Group. Its three sites in Normandy and its site at Meyzieu, near Lyon, manufacture printed circuit boards, mechanical parts and temperature sensors, while also handling the assembly of measuring instruments for all the Group's brands.



4 expert measurement companies in one Group



Portable test and measurement instrumentation



Metering, measurement and energy performance



Temperatures in industrial processes



Metrology and regulatory testing

CONTENTS

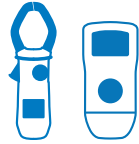

MULTIMETERS

- Clamp multimeters 4
- Multimeters 6



ENVIRONMENTAL MEASUREMENTS

- Thermal camera 9
- Tachometers 9



TESTING AND ELECTRICAL SAFETY

- Assessing the safety of installations 10
- Electrical installation testers 11
- Insulation testers 12
- Earth and resistivity testers 16
- Earth and resistivity kit 16
- Earth and resistivity testers and pylon earth measurement adapter 17
- Earth clamps 18
- Cable and metal duct locator 19
- Micro-ohmmeters 20
- Ratiometer 21



POWER, ENERGY, DISTURBANCES

- Three-phase network and energy analysers 22
- Power and energy loggers 24



OSCILLOSCOPES

- Portable oscilloscopes 26



CURRENT MEASUREMENTS

- AC and AC/DC current measurements 28
- Measurement with oscilloscopes 29
- Ammeters with flexible sensors 30
- Flexible current sensors 31



ACCESSORIES

- Measurement leads 32
- Protection and transport accessories 34

INDEX 35

Find all our news and documentation at
WWW.CHAUVIN-ARNOUX.COM



MULTIMETERS

Digital multimeter clamps

1000 V
CAT IV

IP
54

True
InRush



**3 series of clamps for 3 measurement ranges:
discover our range and choose your clamp!**

F200

600 A_{AC} / 900 A_{DC}
Clamping Ø 34 mm

F400

1,000 A_{AC} / 1,500 A_{DC}
Clamping Ø 48 mm

F600

2,000 A_{AC} / 3,000 A_{DC}
Clamping Ø 60 mm

Voltage up to 1,000 V + Resistance, audible continuity
+ True *InRush*

F201 / F401 / F601

AC applications

Everything you need
for installations
and equipment
powered by the
mains supply

F203 / F403 / F603

AC or DC applications

DC current
Temperature
Adapter function
ΔREL

F205 / F405 / F605

Mixed AC+DC applications + testing and maintenance

Power
THD
ΔREL
Min/Max/Peak
Phase rotation

F407 / F607

Mixed AC+DC applications + analysis and verification







Power
Harmonics
Ripple
Recording
PC software

True *InRush*
A CHAUVIN ARNOUX innovation

Thanks to the TrueInRush function, the clamp automatically determines the type of signal and the level of current in the installation and then adapts the algorithm and measurement procedure to capture the next current surge.

	F201	F203	F205	F401	F403	F405	F407	F601	F603	F605	F607	
Reference	P01120921	P01120923	P01120925	P01120941	P01120943	P01120945	P01120947	P01120961	P01120963	P01120965	P01120967	
Specifications												
Clamping diameter	Ø 34 mm			Ø 48 mm				Ø 60 mm				
Display	LCD	Backlit LCD		Backlit LCD				Backlit LCD				
Resolution	6,000 counts			10,000 counts				10,000 counts				
Number of values displayed	1			1				3		1		3
Type of acquisition	TRMS [AC]	TRMS [AC]/DC	TRMS [AC, AC+DC]/DC	TRMS [AC]	TRMS [AC]/DC	TRMS [AC, AC+DC]/DC		TRMS [AC]	TRMS [AC]/DC	TRMS [AC, AC+DC]/DC		
Autorange function	Yes			Yes				Yes				
Automatic AC/DC detection	Yes			Yes				Yes				
AAC	0.15 to 600 A (900 A peak)			1 000 A				2,000 A (3,000 A peak)				
ADC	0.15 to 900 A peak			1,500 A peak				3,000 A				
AAC+DC			0.15 to 600 A (900 A peak)			1,000 A (1,500 A peak)				2,000 A (3,000 A peak)		
Best accuracy	1 % R + 3 counts			1 % R + 3 counts				1 % R + 3 counts				
VAC	0.15 to 1,000 A (1,400 A peak)			1,000 V				1,000 V				
VDC	0.15 to 1,400 V			1,400 V				1,400 V				
VAC+DC			0.15 to 1,000 V (1,400 V peak)			1,000 A (1,400 A peak)				1,000 A (1,400 A peak)		
Best accuracy	1 % R + 3 cts			1 % R + 3 counts				1 % R + 3 counts				
Frequency of V / I				Yes / -				Yes / Yes				
Resistance	60 kΩ			100 kΩ				100 kΩ				
Audible continuity	Adjustable from 1 Ω to 599 Ω			Adjustable from 1 Ω to 999 Ω				Adjustable from 1 Ω to 999 Ω				
Diode test (semi-conductor junction)	Yes			Yes				Yes				
Adapter	Yes			Yes				Yes				
Single-phase and total three-phase power values	Yes			Yes				Yes				
temperature (K type active (W) reactive (VAR) apparent (VA) FP / DPF	°C: -60.0 to +1,000.0 °C / °F: -76.0 to +1,832 °F			°C: -60.0 to +1,000.0 °C / °F: -76.0 to +1,832 °F				°C: -60.0 to +1,000.0 °C / °F: -76.0 to +1,832 °F				
	Yes / No			Yes / -				Yes / Yes		Yes / -		Yes / Yes
Harmonic analysis THD _v / THD _i	Yes / Yes			Yes / Yes				Yes / Yes				
Frequency analysis	No			No				25th order		25th order		
Phase rotation (2-wire method)	Yes			Yes				Yes				
Functions												
Overcurrent measurement	Yes			Yes				Yes				
Motor Inrush	Yes			Yes				Yes				
Load evolution (TrueInrush)	Yes			Yes				Yes				
Hold	Yes			Yes				Yes				
Min / MAX	Yes			Yes				Yes				
Peak+ / Peak-	Yes			Yes				Yes				
RELative ΔX Differential ΔX / X(%)	Yes / Yes			Yes / Yes				Yes / Yes				
Auto Power Off	Yes			Yes				Yes				
Data recording								Yes		Yes		
Communication interface								Bluetooth		Bluetooth		
Electrical safety according to IEC 61010	600V CAT IV			1,000 V CAT IV - 1,000 V CAT III				1,000 V CAT IV - 1,000 V CAT III				
Power supply	1 x 9 V LF22			4 x 1.5 V AA				4 x 1.5 V AA				
Dimensions / Weight	78 x 222 x 42 mm / 340 g			92 x 272 x 41 mm / 600 g				111 x 296 x 41 mm / 640 g				
Warranty	3 years											

State at delivery

	F201 / F203	F401 / F403 / F601 / F603	F205 / F405 / F605	F407 / F607
 1 set of PVC cables (black/red) with built-in test probes Ø 4 mm isolated elbowed male banana plug	x1			
 1 set of PVC cables (black/red) Ø 4 mm isolated elbowed male banana plug Ø 4 mm isolated straight male banana plug		x1	x1	x1
 2 test probes (black/red) Ø 4 mm isolated female plug		x1	x1	x1
 1 black safety crocodile clip			x1	x2
 1 wire thermocouple with integrated Ø 4 mm isolated banana connections with 19 mm spacing	x1	x1		
 1 x 9 V 6LR61 battery 4 x 1.5V LR03 batteries for F400/600 clamps	x1	x1	x1	x1
 Multifix bag 120 x 245 x 60 mm for F200 clamps 120 x 320 x 60 mm for F400/600 clamps	x1	x1	x1	x1



MULTIMETERS

TRMS AC digital multimeters, up to 6,000 counts

The ergonomic, multi-purpose B-ASYC multimeters cover all the traditional measurements

600 V
CAT III

IEC
61010-2-033

IP
54



	MTX 202	MTX 203	Basic accuracy
Référence	MTX202-Z	MTX203-Z	
Specifications			
Resolution	4,000 counts	6,000 counts	
AC voltage (10 M Ω or 500 k Ω)	0.4 V to 600 V	0.6 V to 750 V	0,5 % + 4 D
DC voltage (10 M Ω)	0.4 V to 600 V	0.6 V to 1,000 V	0,2 % + 2 D
AC/DC current		10 μ A to 6,000 μ A	0,5 % + 5 D
AC /DC current		6 mA to 600 mA	0,5 % + 5 D
AC/DC current	0.02 A to 10 A	0.002 A to 10 A	1 % + 5 D
AC TRMS bandwidth	1 kHz for voltage and current		
Diode test / resolution	3 V / 0.001 V		10 %
Temperature with K thermocouple ($^{\circ}$ C / $^{\circ}$ F)	-55 $^{\circ}$ C to +1,200 $^{\circ}$ C		2 %
Resistance	1 Ω to 40 M Ω	1 Ω to 60 M Ω	0,5 % + 5 D
Continuity	400 Ω - beep < 50 Ω	600 Ω - beep < 50 Ω	-
Capacitance	1 nF to 100 mF		2 % + 5 D
Ingress protection	IP54		
Safety	IEC 61010-2-033 600 V CAT III		
Power supply	2 x 1.5 V AA / LR6 / NEDA15A		
Dimensions / weight	170 x 80 x 50 mm / 320 g		
Warranty	2 years		



Useful: backlit screen and torch



Practical: shockproof, magnetized sheath with compartment for stowing the cables and a 3-position stand

State at delivery

- MTX 202 and MTX 203:**
- 1 shockproof sheath
 - 1.5 m straight lead / red CAT III 600 V test probe,
 - 1.5 m straight lead / black CAT III 600 V test probe,
 - Flexible K thermocouple with \varnothing 4 mm adapter,
 - 1 operating manual on paper,
 - 2 x 1.5 V AA batteries.

Accessories

MULTIFIX accessory	P01102100Z
SHT40KV voltage probe	P01102097
Adapter + K-thermocouple temperature probe	P01102107Z
CMS clamp	HX0064
Set of 2 magnetized test probes	P01103058Z
Fuse F1000 V 10 A, 10 x 38 mm (x 5)	P01297096
Fuse F1000 V 0.63 A, 6,3 x 32 mm (x 5)	P01297098



Multifix accessory
The Multifix accessory is useful for transporting and fixing the multimeter for greater user comfort.



SHT40KV voltage probe
Maximum rated voltage:
40 kVDC, 28 kVrms or 40 kVpeak
Input/output division ratio: 1 kV/1V

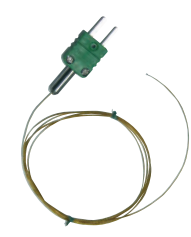

SK thermocouple
For temperature measurement from -50 $^{\circ}$ C to +120 $^{\circ}$ C

TRMS AC, DC, AC+DC digital multimeters

Category IV for safety,
versatility for use in the field

600 V
CAT IV

IP
54



	C.A 5271	C.A 5273	C.A 5275	C.A 5277
Reference	P01196771	P01196773	P01196775	P01196777
Display	6,000 counts	2 x 6,000 counts with backlighting		
Bargraph	61 + 2 elements	61 + 2 elements, dual mode (full scale/central zero)		
Acquisition	TRMS AC /DC		TRMS AC / DC / AC+DC	
Measurement range	5 measurements / second			
Autorange / Deactivatable	Yes / No	Yes / Yes		
Automatic AC /DC detection	Yes		No	
V_{DC}	Ranges	600 mV / 6V / 60V / 600 V / 1,000 V		60 mV / 600 mV / 6 V / 60 V / 600 V / 1,000 V
	Typical accuracy	0.2 % + 2 cts		0.09 % + 2 cts
	Resolution	0.1 mV to 1 V		0.01 mV to 1 V
V_{AC}	Ranges	600 mV / 6 V / 60 V / 600 V / 1,000 V		60 mV / 600 mV / 6V / 60 V / 600 V / 1,000 V
	Resolution	0.1 mV to 1 V		0.01 mV to 1 V
	Bandwidth	40 Hz to 3 kHz		40 Hz to 10 kHz
V_{Low AC} (low impedance + low-pass filter)	Ranges	600 mV / 6V / 60V / 600V / 1,000 V		
	Resolution	0.1 mV to 1 V		
V_{AC + DC}	Ranges	60 mV / 600 mV / 6V / 60 V / 600 V / 1,000 V		
	Resolution	0.01 mV to 1 V		
A_{DC}	Ranges	6 A / 10 A (20 A / 30 s)		6,000 μA / 60mA / 600 mA / 6 A / 10 A (20 A / 30 s)
	Resolution	0.001 A to 0.01 A		1 μA to 0.01 A
A_{AC}	Ranges	6 A / 10 A		6,000 μA / 60 mA / 600 mA / 6 A / 10 A (20 A / 30 s)
	Resolution	0.001 A to 0.01 A		1 μA to 0.01 A
	Ranges			6,000 μA / 60 mA / 600 mA / 6 A / 10 A (20 A / 30 s)
A_{AC + DC}	Resolution			1 μA to 0.01 A
	Ranges	600 Ω / 6,000 Ω / 60 kΩ / 600 kΩ / 6 MΩ / 60 MΩ		
Resistance	Resolution	0.1 Ω to 0.1 MΩ		
Audible continuity		Yes		
Test diode		Yes		
Hz	Ranges	600 Hz / 6 kHz / 50 kHz		
	Resolution	0.1 Hz to 10 Hz		
Capacity	Ranges	6 nF / 60 nF / 600 nF / 6 μF / 60 μF / 600 μF / 6 mF / 60 mF		
	Resolution	0.001 nF (1pF) to 10 μF		
T°	Ranges	-59.6 °C to +1,200 °C -4 °F to +2,192 °F		-59.6 °C to +1,200 °C -4 °F to +2,192 °F
	Resolution	0.1° to 1 °		0.1° to 1 °
Hold		Hold		
Min / MAX (100 ms)	No	Yes		
Peak+ / Peak- (1 ms)		No	Yes	
Differential measurement (X) / Relative (DX/X%)		No	Yes	
Automatic power-off		Yes (deactivatable)		
Power supply		1 x 9 V		
Dimensions / Weight		90 x 190 x 45 / 400 g		

State at delivery

C.A 5270 multimeter delivered with a set of banana leads, a set of test probes, a 9 V battery and a CD containing the operating manual and the start-up guide.

C.A 5271 standard state at delivery

C.A 5273 with additional K thermocouple temperature sensor



C.A 5275 with additional bag and Multifix adapter

C.A 5277 with additional K thermocouple temperature sensor, bag and Multifix adapter

ASYC IV Range digital multimeters

The 1st multimeters with graphical colour screens!



	MTX 3290	MTX 3291 *	MTX 3292	MTX 3293
Reference	MTX3290	MTX3291	MTX3292 MTX3292-BT 	MTX3293 MTX3293-BT 
DC, AC and AC+DC voltages	60 mV to 1,000 V		-40 to +1,200°C	
DC accuracy	0.3%	0.05%	0.03%	0.02%
AC and AC+DC bandwidth	20 kHz	100 kHz	100 kHz	200 kHz
DC, AC and AC+DC current	600 µA to 10 A /20 A (30 s max)*		1,000 µA to 10 A / 20 A (30 s max)	
DC accuracy	0.08%		0.01%	
Frequency	60 Hz to 600 kHz		10 Hz to 5 MHz	
Resistance	600 Ω to 60 MΩ		100 Ω to 100 MΩ	
Audible continuity	600 Ω SIGNAL <30 Ω ±5 Ω < 5V		1000 Ω SIGNAL <20 Ω < 3.5V	
Diode test	3 V with 1 mV		Diode 0 -2.6 V <1 mA + Zener Diode or LED 0-20 V<11 mA	
Capacitance	6 nF to 60 mF		1 nF to 10 mF	
Temperature Pt100/1000	-200°C to 800°C			
Temperature K/J TC	-40 to +1,200°C			
Other functions				
Surveillance	Time/date-stamped MAX/MIN /AVG or PEAK ±, on all the main positions		SURV time/date-stamped MAX/MIN /AVG or PEAK ±, on all the main positions	
REL	REL relative value + measured reference value on secondary display*		Relative value REF-delta unit or on 3 displays + main measurement	
PWM filter	4 th -order 300 Hz low-pass filter for measuring on variable speed drives of asynchronous motors			
V-output clamp function for direct reading	Integration of the ratio: 1/1 ,1/10,1/100,1/1000 mV/A		Parameterizable Ax ratio	
Secondary functions or measurements	dBm and VA resistive power, +/- duty cycle, and pulse width*		3 measurements + main measurement	
SPEC	Display of measurement tolerance: Smin, Smax			
GRAPH	Trends of main measurements <60s + Zoom + Cursor			
Central zero	Selectable or automatic* bargraph for VDC and IDC		Automatic trend bargraph	
Measurement storage			1,000	6,500
General specifications				
Type of display	LCD with backlighting* and digits 14 mm high Double 60,000* or 6,000-count display		Colour graphical display (70x52) with backlighting on 4 100,000-count displays	
PC interfaces			USB optical connector & SX-DMM software	USB optical connector or Bluetooth (option)- SX-DMM software
Alimentation	4 x AA batteries or Ni-MH batteries		Charger or 4 x AA batteries or Ni-MH batteries	
Safety	Safety as per IEC 61010-1 1,000V-CATIII / 600V CAT IV* OR 600V CAT III / 300V CAT IV – Safety as per IEC 61010-2-033		Safety as per IEC 61010-1 1,000V-CAT III /600V CAT IV – Safety as per IEC 61010-2-033	
Environment	Storage: -20 °C to +70 °C – Operation: -10 °C to +55 °C		Storage: -20 °C to +70 °C – Operation: 0 °C to +40 °C	
Mechanical specifications	Dimensions (L x W x H): 196x90x47.1 mm – Weight: 570 g			
Warranty	3 years			

State at delivery

- **MTX 3290:** delivered with 4 x 1.5 V alkaline batteries, 1 red straight/straight lead 1.5 m long, 1 black straight/straight lead 1.5 m long, 1 red CAT IV 1 kV test probe, 1 black CAT IV 1 kV test probe, 1 user's manual on CD and 1 start-up guide on paper
- **MTX 3291:** delivered with 4 x 1.5 V alkaline batteries, 1 red straight/straight lead 1.5 m long, 1 black straight/straight lead 1.5 m long, 1 red CAT IV 1 kV test probe, 1 black CAT IV 1 kV test probe, 1 user's manual on CD and 1 start-up guide on paper plus 1 bag, 1 USB cable and 1 user's programming manual SCPI and SX-DMM software
- **MTX 3292** and **MTX 3293:** delivered with 1 bag, 4 NI-MH 2400mAh 1.5 V rechargeable batteries, 1 charger, 1 red straight/straight lead 1.5 m long, 1 black straight/straight lead 1.5 m long, 1 red CAT IV 1 kV test probe, 1 black CAT IV 1 kV test probe, 1 optical USB cable + SX-DMM software, 1 user's manual on CD and 1 user's programming manual SCPI, 1 start-up guide on paper

Accessories

- MTX329X graphical colour calibration software > **HX0059B**
- Kit of 4 Ni-MH rechargeable batteries. > **HX0051B**
- External charger MTX 328X, MTX 329X (4 batteries included) . . . > **HX0053B**
- MTX digital DMM transport kit. > **HX0052B**
- Graphical colour DMM transport kit. > **HX0052C**
- MTX 3290 / 3291 calibration software. > **P01196770**





ENVIRONMENTAL MEASUREMENTS

Thermal camera

- > 13-hour battery life
- > Focus-free with 20° x 20° field of view
- > Voice annotations to record your comments directly on the image
- > Connectivity with current clamps and multimeters: all the necessary measurements simultaneously



C.A 1950 P01651901	
Reference	C.A 1950 P01651901
Detector	80 x 80
Type	UFPA microbolometer, 8 - 14 μm
Frequency	9 Hz
Sensitivity (N.E.T.D)	80 mK @ 30 °C (0.08 °C @ 30 °C)
Temperature measurement	
Temperature range	-20 °C to +250 °C
Accuracy	±2 °C or ±2 % of reading
Image performance	
Thermal image	
Field of view	20° x 20°
IFOV (spatial resolution)	4.4 mrad
Focus	Fixed
Minimum focal distance	40 cm
Real image	Yes (320 x 240 pixels)
Display mode	Thermal image, real image with automatic parallax compensation. Image merging available PC software
Functions for analysis	
Measurement tools	1 manual cursor + 1 automatic detection + Min-Max on adjustable area + temperature profile + Isotherm
Parameter settings	Emissivity, environmental temperature, distance, relative humidity
Voice comments	Yes by Bluetooth (earphones supplied)
Connectivity	F407 and F607 clamps, MTX 3292 and MTX 3293 multimeters
Data storage	On 2 GB removable micro SD card (approx. 4,000 images), up to 32 GB possible
Image format	.bmp (thermal and real images recorded simultaneously)
Presentation of image	
Adjustment	Automatic or manual adjustment of palette min-max
Freezing of image	Animated or fixed image
Image display	Multi-palette
Screen	2.8 inches
Power supply	
Type	Rechargeable NiMH batteries with low self-discharge
Recharging	External (charger supplied)
Battery life	13 hrs 30 min (typical) / Brightness 50 % Bluetooth off
Environmental specifications	
Operating temperature	-15 °C to +50 °C (-4 °F to +122 °F)
Storage temperature range	-40 °C to +70 °C (-40 °F to +158 °F)
Humidity	10 % to 95 %
Compliance	EN 61326-1: 2006 / EN 61010-1 Ed. 2
Fall resistance	2 metres on all surfaces
Shock resistance	25 G
Vibration resistance	2 G
Physical specifications	
Weight / dimensions	700 g with rechargeable batteries / 225 x 125 x 83
Ingress protection	IP 54
Interfaces	USB link and Mass Storage function: the product is then recognized as a USB drive for easy transfer of the images
Bluetooth for connectivity with earphones (voice comments) and Chauvin Arnoux® Metrix® measuring instruments (F407, F607, MTX 3292, MTX 3293)	Yes, ¼" insert on camera
General specifications	
Report creation software	Supplied as standard with automatic report generation in .pdf or .docx
Warranty	2 years



Simultaneous recovery of the measurements via Bluetooth

State at delivery

C.A 1950: delivered in hard case with 4 NiMH batteries and battery charger, 1 micro SD HD card, 1 USB cable, 1 set of Bluetooth earphones, CamReport software on CD ROM, user manuals.

Tachometers

- Measurement up to 100,000 RPM
- Contact and non-contact measurement
- Wide range of functions available: rotation speed, linear, counting, frequency, period
- Possibility of programming and storage capacity for the C.A 1727
- USB link for processing the records on PC for the C.A 1727

State at delivery

• **C.A 1725** and **C.A 1727:** delivered in a hard case with 1 FRB F connector, a 9 V battery, 1 set of 15 reflective strips (length: 0.1 m), 1 operating manual on CD and 1 printed quick startup guide + only available for C.A 1727: 1 TACHOGRAPH software on CD-Rom

Accessories

Mechanical accessories kit	P01174902
End fittings (set of 3)	P01174903
Reflective strips (15 x 0.1 m strips)	P01101797
FRB F connector	P01101785
TACHOGRAPH software on CD-Rom	P01174835
Cable: USB-A to USB-B	P01295293



		C.A 1725	C.A 1727
Reference		P01174810	P01174830
RPM function	Range	6 to 100,000 RPM	
	Accuracy	10-4 R ± 6 cts	
m/min function	Range	0.6 to 60,000 m/min	
	Accuracy	10-4 R ± 1 increment	
Hz function	Range	0.1 to 10,000 Hz	
	Accuracy	4 x 10-5 R ± 4 cts	
ms function	Range	0.1 to 10,000 ms	
	Accuracy	10-4 R ± 5 cts	
Ratio function	Range	10 to 10,000 %	
	Accuracy	0.1 % to 1 %	
Counting function	Range	0 to 99,999 events	
	Accuracy	± 1 event	
Functions		Min., Max., HOLD, Smoothing	
Storage		High and low alarms	
Dimensions / Weight		4,000 alarms	
		21 x 72 x 47 mm / 250 g	

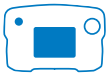

Assess the electrical safety of installations

The measurements according to the applicable European standards:

IEC 60364,
EN 61557,
NF C 15-100,
VDE 0100,
NIN/NIV,
IEE 17th.

Whatever the environment, electrical installation testers help electricians to certify that the infrastructures under their responsibility are safe.

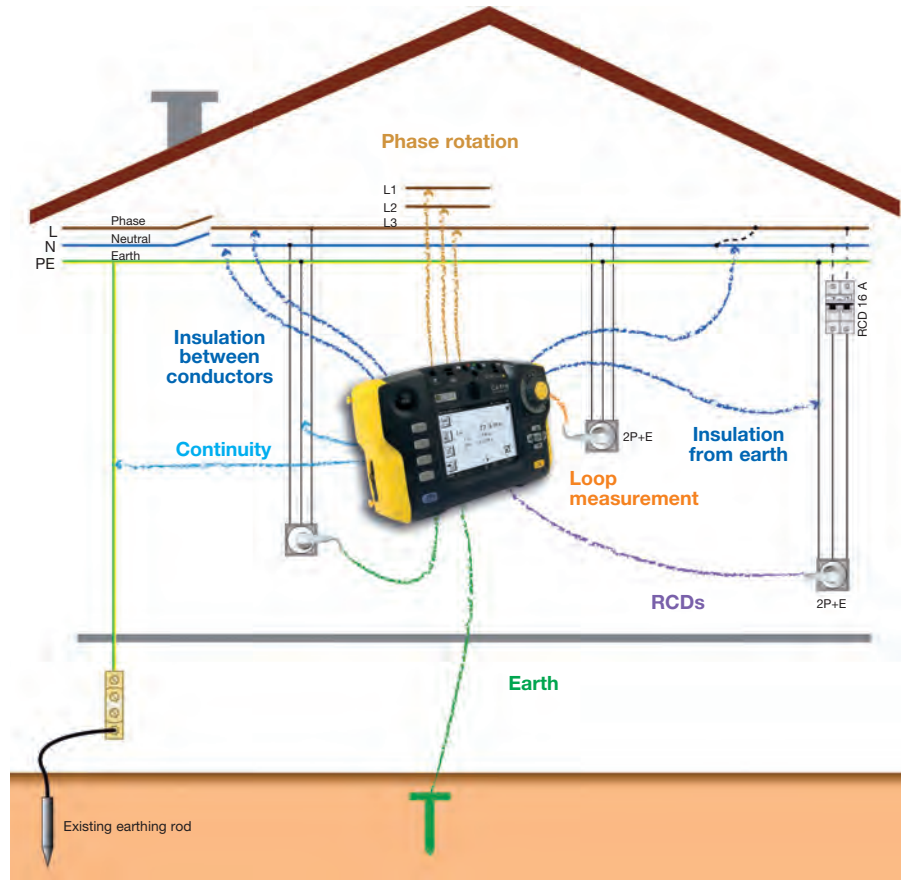

INSULATION
(IEC/EN 61557-2)
Measurement with power off

Why measure insulation?

- To check that no conductor has suffered mechanical damage
- To check that all conductors are isolated from earth

Voltage of installation	Test voltage	Insulation required
< 50 V	250 V	≥ 250 kΩ
50 V to 500 V	500 V	≥ 500 kΩ or ≥ 1 MΩ depending on the standards
> 500 V	1,000 V	≥ 1 MΩ

EARTH (IEC/EN 61557-5)

Why and how is the earth measured?

- By the single auxiliary rod method (TT & impedant IT networks)
- The Ra must be as low as possible to allow fault currents to flow to earth

PHASE ROTATION
(IEC/EN 61557-7)

How are the different phases in a three-phase network identified?

- By a clear indication of their rotation direction.

CONTINUITY
(IEC/EN 61557-4)
(I ≥ 200 mA)

Why check continuity?

- A PE conductor in good condition and properly connected to the earth bar will drain faults to earth.

RCDs
(IEC/EN 61557-6)

Why test RCDs?

- To check that they trip
 - At $I_{test} = \Delta I_N$
 - In preventive maintenance, in less than 300 ms for the standard types and 500 ms for the selective types, at a current between $\Delta I_N/2$ and ΔI_N .

LOOP
(IEC/EN 61557-3)

Why measure loops?

- To measure the earth by excess, without using rods
- To calculate the short-circuit current to ensure safety devices are proportionate
- To check fault voltage (with probe connected)

Installation Testers

600 V
CAT III

IP
53



C.A 6116N

C.A 6117

CONTINUITY / RESISTANCE	
I rated / Range / Resolution	I > 200 mA / 39.99 Ω / 0.01 Ω / ± (1.5% of measurement + 2 cts) 12 mA / 39.99 Ω and 399.9 Ω / 0.01 and 0.1 Ω / ± (1.5% of measurement + 5 cts) with audible beep
Range / Accuracy	4 kΩ / 1 Ω / ±(1.5 % of measurement + 5 cts) • 40 kΩ - 400 kΩ / 10 Ω - 100 Ω / ±(1.5 % of measurement + 2 cts)
INSULATION	
Rated voltage	U _{test} : 50 / 100 / 250 / 500 / 1,000 V DC
Range / Accuracy	0.01 MΩ to 2 GΩ / ±(5 % of measurement + 3 cts)
Short-circuit current	≤ 3mA
EARTH	
3P EARTH Range / Resolution / Accuracy	0.50 Ω to 40 Ω / 0.01 Ω / ±(2 % of measurement + 10 cts) • 40 Ω to 15 kΩ / 0.1 Ω to 1 Ω / ±(2 % of measurement + 2 cts) 15 kΩ to 40 kΩ / 10 Ω / ±(10 % of measurement + 2 cts)
Others	Measurement of RH & RS auxiliary stake resistance (up to 40 kΩ)
U _{fk}	Complies with SEV 3569
LOOP IMPEDANCE (Z _s (L-PE) and Z _i (L-N ou L-L) - 1P LIVE EARTH	
LIVE EARTH Installation voltage / freq.	90 to 500 V / 15.8 to 17.5 Hz - 45 to 65 Hz
High-current mode or TRIP mode Z _s (L-PE) & Z _i (L-N or L-L)	Max. test current: 7.5 A
Range / Basic accuracy	(0.050) 0.100 Ω to 399.99 Ω / ± (5% of measurement + 2 cts)
NO TRIP mode (Z _s (L-PE) only)	Test current: 6 mA - 9 mA - 12 mA (as required)
Range / Basic accuracy	0.20 Ω to 3,999 Ω / ± (5 % of measurement + 2 cts)
Calculation of short-circuit current I _k (PFC (Z _s), I _{Sc} PSCC (Z _i))	Fault current and short-circuit current: 0.1 A to 20 kA
Integrated fuse table	Yes
Voltage drop ΔV%(Z _i)	-40 % to +40 %
Others	Measurement of the resistance and inductive components of the impedances Z _s and Z _i
RCDs - TYPES AC and A	
Installation voltage / Frequency	90 V to 500 V / 15.8 Hz to 17.5 Hz and 45 Hz to 65 Hz
IΔn / Ramp and pulse test	10/30/100/300/500/650/1,000 mA (90 V - 280 V) or variable - 10/30/100/300/500 mA (280 V - 550 V) or variable
No-trip test	At ½ IΔn - Duration: 1,000 ms or 2,000 ms
Ramp mode	0.2 to 0.5 x IΔn (U _f) / 0.3 x IΔn to 1.06 x IΔn per step of 3.3 % x IΔn
Trip time measurement : Range / Resolution / Accuracy	0.2 to 0.5 x IΔn (U _f) / 0.5 x IΔn / 2 x IΔn (selective) / 5 x IΔn Pulse: 0 to 500 ms / 0.1 and 1 ms / 2ms. Ramp mode: 0 to 200 ms / 0.1 ms / 2 ms
RCDs - TYPE B	
Installation voltage / Frequency	90 V to 275 V / 15.8 Hz to 17.5 Hz and 45 Hz to 65 Hz
IΔn : rampe / pulse k x IΔn	2 x IΔn : 10/30/100/300/500 mA ; 4 x IΔn: 10/30/100 mA Duration: 150 ms en 4 x IΔn ou 300 ms en 2 x IΔn
Test in ramp mode	0.2 x IΔn to 2.2 x IΔn
Trip test: k x IΔn 4 x IΔn	IΔn ≤ 200 mA: 2.2 x 2 x IΔn IΔn > 200 mA: 1.1 x 2 x IΔn IΔn ≤ 100 mA: 2.2 x 4 IΔn
AUTRES MESURES	
Current via C177A clamp (1mA*)	5.0 mA to 199.9 A (C177A)
Voltage / Frequency	0 to 550 VAC/DC / DC and 15.8 to 500 Hz / 10 to 500 Hz
Phase rotation / Active power	20 to 500 VAC / 0 to 110 kW single-phase - 0 to 330 kW three-phase Display of voltage and current waveforms simultaneously
Harmonics	Voltage and current / up to 50th order / THD-F / THD-R
GENERAL SPECIFICATIONS	
Display	Large 5.7" graphical colour LCD screen with bakclighting, 320 x 240 points
Data storage/Communication	1,000 tests / via USB for data transfer and report creation
Power supply: rechargeable battery / Battery life	Lithium-ion 10.8V rated 5.8AH / up to 30 hours
Dimensions / weight	280 x 190 x 128 mm / 2.2 kg
Ingress protection / EMC	IP 53 / IK04 / IEC 61326-1
Electrical safety	IEC 61010 -1 - 600 V CAT III - 300 V CAT IV - IEC 61557

* if a voltage is connected to the instrument

State at delivery

• C.A 6116N • C.A 6117:

1 tester delivered with a carrying bag, 1 type-2 mains power pack / charger, 1 Li-Ion battery pack, 1 USB A/B cable, 1,80 m, with ferrite, 1 three-point cable - 3 safety leads (red, blue and green), 3 test probes, Ø 4mm (red, blue and green), 3 crocodile clips (red, blue and green), 2 elbowed-straight safety leads, 3 m (red and black), 1 three-point Euro mains cable, 1 x 2P EURO mains cable, 1 remote-control probe, 1 wrist strap, 1 scratch-proof film mounted on the instrument, 1 x 4-point hands-free strap, ICT data export software on CD-ROM, 6 operating manuals on CD (one per language), 1 safety datasheet in 20 languages.

References

- C.A 6116N EURO Contrôleur P01145455 X*
- C.A 6117 EURO Contrôleur..... P01145460 X*

*FR version A=X, IT version A= B, CH version A= C, US version A= D





Insulation and Continuity Testers

Discover our new range:

- > Test voltage from 10 V to 1,000 V / 200 GΩ
- > Manual, Lock, Timer and PI / DAR Ratios modes
- > Visual Pass / Fail: red / green
- > 200 mA / 20 mA continuity with active protection without fuses
- > Measurement of V (TRMS & DC), F, Ω, kΩ, C and cable length
- > ΔRel mode & configurable alarms
- > Storage of measurements in memory



600 V
CAT IV

IP
54

IEC
61557



TRMS

Choose your tester to match your needs:

C.A 6536

"Special" applications

With a variable test voltage from 10 V to 100 V in 1 V increments, this model is intended for special applications in sectors such as avionics, space and defence, which often require a low test voltage and strict adherence to the programmed value.

C.A 6532

"Telecommunications" applications

- Insulation tests at 50 V or 100 V
- Specific functions: measurement of resistance, capacitance, leakage current and AC voltage.
- Measurement of the difference in resistance between 2 wires in a pair by using the ΔREL function.
- Display of the length of the line being tested, thanks to programming of the linear capacitance in nF/km.

C.A 6522, C.A 6524, C.A 6526

"Industrial Maintenance" applications

- Periodic insulation tests on installations and equipment help to prevent incidents by setting up preventive maintenance designed to detect ageing and premature deterioration of their insulation characteristics:
- Measurement of insulation over a programmed duration
 - Alarms and Pass/Fail indicator light (C.A 6526)
 - PI and DAR ratios to determine the quality of the insulation, with the advantage of not being significantly influenced by the temperature
 - Storage in memory to compare the measurement histories

C.A 6534

"Electronics" applications

Thanks to its wide test-voltage range from 10 V to 500 V, this model covers the specific requirements of the electronics industries, for both low-current applications and power stages. Its measurement range is from 2 kΩ to 50 GΩ. With appropriate electrodes, the 10 V and 100 V test voltages can also be used for electrostatic discharge applications.

Remote control probe

The remote control probe is an accessory specially developed to make your insulation tests in the field simpler and quicker.

- Insulation measurement can be triggered with a single press on the probe's yellow button.
- Equipped with a torch function, this probe effectively lights the point of measurement.
- Thanks to the tester's backlit screen, the measurement results are visible at all times, including in places with poor lighting.



Reference P01102092A

DataView® software

DataView® software, with its Megohmmeter Transfer module, automatically recognizes the instrument when it is connected to the PC and opens the corresponding menu. This tree-structure menu offers users direct access to the data recorded in the instrument and its configuration.

The other functions available are:

- Activation of remote tests
- Real-time display
- DAR and PI references
- Graphical plot of the tests
- Generation of measurement reports

Reference P01102095





	C.A 6522	C.A 6524	C.A 6526	C.A 6532	C.A 6534	C.A 6536
Reference	P01140822	P01140824	P01140826	P01140832	P01140834	P01140836
Application	Industrial Maintenance			Telecom	Electronics / ESD	Special
Voltage						
Measurement range / Resolution	0.3V - 399.9 V / 0.1 V; 400V-700V / 1V					
Accuracy / Input impedance	+/- (3% + 2cts) / 400 kΩ					
Operating frequency	DC; 15.3 - 800 Hz					
Frequency						
Measurement range / Resolution / Accuracy	*15.3 Hz- 399.9 Hz / 0.1 Hz / +/- (0.5% + 2cts) ; 400-800 Hz / 1 Hz / +/- (1% + 1ct)*					
Insulation						
Test voltage	250-500-1,000V	50 - 100 - 250 - 500 - 1 000 V		50 - 100 V	10 - 25 - 100 - 250 - 500 V	10 to 100V in 1V increments
Range at maximum test voltage	40 GΩ	200 GΩ		20 GΩ	50 GΩ	20 GΩ
Compliance with IEC 61557-2 standard		2 GΩ		2 GΩ		2 GΩ
Measurement range: 10 V					2 kΩ - 1 GΩ	2 kΩ - 2 GΩ
25 V					5 kΩ - 2 GΩ	(U _v /5) kΩ - (U _v /5) GΩ
50 V		10 kΩ - 10 GΩ		10 kΩ - 10 GΩ		
100 V		20 kΩ - 20 GΩ		20 kΩ - 20 GΩ	20 kΩ - 10 GΩ	20 kΩ - 20 GΩ
250 V	50 kΩ - 10 GΩ	50 kΩ - 50 GΩ			50 kΩ - 25 GΩ	
500 V	100 kΩ - 20 GΩ	100 kΩ - 100 GΩ			100 kΩ - 50 GΩ	
1,000 V	200 kΩ - 40 GΩ	200 kΩ - 200 GΩ				
Variable test voltage						10V to 100V
Measurement range / resolution	10 ⁽¹⁾ -999 kΩ and 1,000-3,999 MΩ / 1 kΩ; 4,00 - 39,99 MΩ / 10 kΩ; 40,0-399,9 MΩ / 100 kΩ; 400 - 3999 MΩ / 1 MΩ; 4,00 - 39,99 GΩ / 10 MΩ; 40,0 - 200 GΩ / 100 MΩ					
Accuracy	± (3 % + 2 cts) ⁽²⁾					
Test voltage (I < 1 mA)	-0 % + 20 %					
Display of test voltage	± (3 % + 3 cts)					
Display of test current / resolution	0,01 µA - 39,99 µA / 10 nA; 40,0-399,9 µA / 100 nA; 0,400-2,000 mA / 1 µA					
Accuracy of test current	± (10 % + 3 cts)					
PI/DAR ratios	10 mn / 1 mn - 1 mn / 30 s					
Timer (min:s)	0:00 - 39:59					
Discharge time (at 25 V)	< 2 s/µF					
Alarms	2 fixed thresholds + 1 programmable threshold					
Continuity						
Range for continuity measurement	0,00 Ω - 10,00 Ω (200 mA)		0,00 Ω - 10,00 Ω (200 mA) ; 0,0 - 100,0 Ω (20 mA)			
Accuracy / Open-circuit voltage	± (2 % + 2 cts) / ≥ 6 V					
Measurement current	-0%+4%					
Continuity thresholds (quick beep)	2 Ω fixed		2 Ω, 1 Ω, 2Ω, 1Ω, programmable threshold			
Compensation of cables	up to 9,99 Ω					
Resistance						
Measurement range / Resolution / Accuracy	0 - 3999 Ω / 1 Ω; 4,00 kΩ - 39,99 kΩ / 10 Ω / ± (3 % + 2 cts) 40,0 kΩ - 399,9 kΩ / 100 Ω; 400 kΩ - 1 000 kΩ / 1 kΩ / ± (3 % + 2 cts)					
Capacitance						
Measurement range / resolution	0,1 nF - 399,9 nF / 0,1 nF 400 nF - 3999 nF / 1 nF 4,00 µF - 10,0 µF / 10 nF					
Accuracy	± (3 % + 2 cts)					
Line length	0 - 100 km					
General specifications						
Display	2 x 4,000 cts + logarithmic bargraph					
Storage	300 measurements			1,300 measurements		
Communication	Bluetooth® Classe II					
Power supply / Automatic shutdown	6 x LR6(AA) batteries / 5 min , deactivatable					
Battery life	1,500/2,500/6,000 measurements ⁽⁴⁾ ; UN x 1 kΩ @ UN (5s ON / 5s OFF); 3,000 continuity measurements (5s ON / 5s OFF)					
Dimensions (h x w x d) / Weight / IP rating	211 x 108 x 60 mm / 850 g / IP 54 / IK 04					
EMC / Electrical safety	IEC 61326-1 / IEC 61010-1 and IEC 61010-2-030, 600V CAT IV					
Compliance with standards	IEC 61557 parts 1, 2, 4 and 10					

(1) : 2 kΩ for C.A 6532 - C.A 6534 - C.A 6536 – (2): to be added: 10 V: 1% per 0.1 GΩ; 25 V: 0.4% per 0.1GΩ; 50 V: 2% per GΩ; 100 V: 1% per GΩ; 250 V : 0.4% per GΩ; 500 V: 0.2% per GΩ; 1,000 V: 0.1% per GΩ – (3): 10%/UN is added per 100 MΩ – (4): depending on the model.

Accessories and replacement parts

Continuity rod	P01102084A	2 test probes (red and black)	P01295454Z
C.A 861 thermometer + K thermocouple	P01650101Z	2 wire grips (red and black)	P01102053Z
USB-Bluetooth adapter	P01102112	Carrying bag for hands-free use	P01298049
2 elbowed-straight safety leads (red and black) 1.50 m long.	P01295453Z		
2 crocodile clips (red and black)	P01295457Z		

State at delivery

- **C.A 6522 et C.A 6524** delivered with a carrying bag for hands-free use, 2 elbowed-straight safety leads (red and black) 1.50 m long, one red crocodile clip, one black test probe, 6 x LR6 or AA batteries, multilingual user's manual on CD, a quick start-up guide, multilingual safety datasheet.
- **C.A 6526**, ditto + a CD containing the Megohmmeter Transfer software.
- **C.A 6532 and C.A 6534**, same as C.A 6526 + 2 wire-grips (red and black).
- **C.A 6536**, same as C.A 6524 + 2 wire-grips (red and black).





ELECTRICAL TESTING AND SAFETY

Insulation testers



	C.A 6541	C.A 6543	C.A 6505	C.A 6545	C.A 6547	C.A 6549
	<i>Quantitative and qualitative measurement</i>	<i>Saving of measurements Rechargeable battery</i>	<i>Insulation and leakage current</i>	<i>Insulation, capacitance, current</i>	<i>Storage and communication</i>	<i>For preventive maintenance professionals</i>
Reference	P01138901	P01138902	P01139704	P01139701	P01139702	P01139703
Voltage	1 to 1,000 V _{AC/DC}		1 to 5,100 V _{AC/DC}			
Insulation	50 / 100 / 250 / 500 / 1,000 V _{DC}		500/1,000/ 2,500 / 5,000 V _{DC} + variable from 50 V to 5,100 V _{DC} (10 or 100 V increments)			
Range	2 kΩ to 4 TΩ		10 kΩ to 10 TΩ			
Continuity	0.01 to 40 Ω (buzzer + cable compensation)					
Resistance	0.01 to 400 kΩ					
Capacitance	0.005 to 4.999 μF			0.001 to 49.99 μF		
Current	0.001 nA to 3,000 μA					
Voltage ramp mode						5 steps
R calcul. (ref. T°)						yes
Alarms	yes					
Smoothed display	yes	no		yes		
Chronometer	yes					
Prog. test time	yes					
Quality ratios	DAR / PI			DAR / PI / DD		
R(t)	storage of samples		no	storage of samples		display on screen
Storage	128 kB		4 kB		128 kB	
Communication	two-way		no		two-way	
Power supply	8 x LR14 batteries		NiMH rechargeable battery			
Safety	IEC 61010-1 Cat. III 600 V IEC 61557		IEC 61010-1 Cat. III 1000 V (Cat. I, 2,500 V)- IEC 61557			
Display	giant LCD + bargraph		giant LCD + bargraph			graphic
Backlighting	yes					
Dimensions	240 x 185 x 110 mm		270 x 250 x 180 mm			
Weight	3.4 kg		4.3 kg			
PC software	no	Dataview® (option)		no	Dataview® (option)	
State at delivery	carrying bag containing: 3 leads 1.5 m long (including one shielded), 3 crocodile clips, 1 test probe + batteries or power cable		carrying bag containing: 3 HV leads 3 m long with large crocodile clips (including one shielded), 1 lead with rear connection (35 cm) + 1 power cable			

DataView® software for C.A 6543, C.A 6547 and C.A 6549

DataView®: the essential tool for configuring and performing the measurements, viewing the data in real time, recovering the recorded data and creating standard or customized measurement reports.. **P01102095**

Digital insulation testers

- > Wide measurement range from 10 k Ω to 30 T Ω
 - 5 mA charging current
 - Large backlit LCD screen with digital display, bargraph and R(t)+u(t), i(t) and i(u) graphs
 - Automatic calculation of DAR / PI / DD / ΔR (ppm/V) ratios
- > 3 filters to optimize measurement stability



	C.A 6550	C.A 6555
Reference	P01139705	P01139706
Voltage	10 kV	15 kV
Insulation	500/1,000/2,500/5,000/10,000 V	500/1,000/2,500/5,000/10,000/15,000 V
Range	10 k Ω to 25 T Ω	10 k Ω to 30 T Ω
Continuity		Yes
Resistance		Yes
Capacitance		0.001 - 9.999 μ F / 10.00 - 49.99 μ F
Current		Leakage current from 0 to 10 mA
Voltage ramp mode		3 pre-configurable ramps
R calcul. (ref. T°)		Yes
Alarms		Yes
Smoothed display		Yes
Chronometer		Yes
Prog. test time		Yes
Quality ratios		DAR / PI / DD / ΔR (ppm/V)
R(t)		Display on screen
R(t) + U(t), I(t), I(u)		Graphic display of curves
Storage		256 kB, up to 80,000 recordings
Communication		Optically-isolated port for USB and RS232 link
Power supply		NiMH battery rechargeable with external voltage
Safety		1,000 V Cat. IV - IEC 61010-1 and IEC 61557
Backlighting		Yes
Dimensions		340 x 300 x 200 mm
Weight		6.2 kg

State at delivery

Delivered with bag containing :

- 2 safety leads 3m long equipped with an HV connector at each end (red / blue),
- shielded safety lead 3 m long equipped with an HV connector at one end and an HV connector with rear connection (black) at the other end,
- 3 crocodile clips (red, blue, black),
- 2 x CAT IV 1000 V test probes (red, black) for voltage measurement,
- 1 blue lead with rear connection,
- 1 mains power cable 2 m long,
- DataView® software,
- 1 optical / USB communication lead,
- 1 operating manual in 5 languages on CD-ROM

Accessories

3 HV leads with croc. clips for 10/15 kV	P01295466
Blue 8 m HV lead with croc. clips	P01295468
Red 8 m HV lead with croc. clips	P01295469
Black 8 m HV lead with croc. clips	P01295470
Blue 15 m HV lead with croc. clips	P01295471
Red 15 m HV lead with croc. clips	P01295472
Black 15 m HV lead with croc. clips	P01295473
3 x 3 m HV leads for 10/15 kV.	P01295465
50 cm HV lead with rear connection	P01295467
2 red/black test probes	P01295454Z
3 crocodile clips: red/blue/black	P01103062
Bag	P01298066



ELECTRICAL TESTING AND SAFETY

Earth and resistivity testers



		C.A 6460	C.A 6462	C.A 6470N	C.A 6471
Reference		P01126501	P01126502	P01126506	P01126505
3P Method	Range	0.01 to 2,000 Ω		0.01 Ω to 99.99 kΩ	
	Resolution	10 mΩ/100 mΩ/1 Ω		0.01 to 100 Ω	
	Measurement frequency	128 Hz		41 to 513 Hz	
	Coupling measurement	Yes		Yes	
4P Method	Range	0.01 to 2,000 Ω		0.001 Ω to 99.99 kΩ	
	Resolution	10 mΩ/100 mΩ/1 Ω		0.001 to 100 Ω	
	4P Selective			Yes	
Earth measurement with 2 clamps	Range			0.01 to 500 Ω	
	Resolution	No		0.01 to 1 Ω	
	Measurement frequency			Auto: 1367 Hz Manual: 128 Hz, 1367 Hz, 1611 Hz, 1758 Hz	
Resistivity	Test method	Wenner et Schlumberger		Wenner and Schlumberger with automatic calculation	
	Range	0,01 to 99,9 kΩ		0.01 to 99.9 kΩ	
	Measurement frequency	128 Hz		41 to 128 Hz	
DC resistance measurement	Type of measurement			2 or 4 wires	
	Range	No		0.12 Ω to 99.9 kΩ	0.001 Ω to 99.9 kΩ
	Measurement current			> 200 mA DC	
Storage	No		512 memory locations		
Communication	No		Optically-isolated USB		
Dimensions / weight	273 x 247 x 127 mm / 2.8 kg / 3.3 kg		272 x 250 x 128 mm / 3 kg / 3.2 kg		
Safety	50 V CAT III, IEC 61010 & IEC 61557		50 V CAT IV, IEC 61010 & IEC 61557		

State at delivery

- **C.A 6460** : delivered with 8 x 1.5 V LR6 batteries and 1 operating manual in 5 languages
- **C.A 6462**: delivered with 1 mains lead for recharging and 1 operating manual in 5 languages
- **C.A 6470N**: delivered with 1 external mains charger, data export software + optical / USB communication lead, 5 operating manuals (one per language) on CD-ROM, 5 simplified operating manuals, each in a different language, 5 descriptive labels, each in a different language
- **C.A 6471**: delivered with 1 external mains charger, data export software + optical / USB communication lead, 2 C182 clamps with 2 safety leads, 5 operating manuals (one per language) on CD-ROM, 5 simplified operating manuals, each in a different language, 5 descriptive labels, each in a different language, 1 carrying bag.

Accessories

C.A 6471

- MN82 clamp (diam. 20mm) (delivered with 1 x 2m cable for ES terminal connection) . . **P01120452**
- C182 clamp (diam. 20mm) (delivered with 1 x 2m cable for ES terminal connection) . . **P01120333**

Earth and resistivity kit (100 m kit)

Ref.: **P01102024**

Compartment bag with space for tester containing: 4 "T"-shaped rods, 4 coils of cable (100 m red, 100 m blue, 100m green, 30 m black), 1 green 10 m cable coiler, 1 mallet, 5 x Ø 4 mm lug/banana plug adapters



Standard 3P-method earth kit

50 m kit Ref.: P01102021

Carrying case containing: 2 "T"-shaped rods, 2 coils of cable (50 m red, 50 m blue), 1 green 10 m cable coiler, 1 mallet, 5 x Ø 4 mm lug/banana plug adapters

100 m kit Ref.: P01102022

Carrying case containing: 2 "T"-shaped rodss, 2 coils of cable (100 m red, 100 m blue), 1 green 10 m cable coiler, 1 mallet, 5 x Ø 4 mm lug/banana plug adapters

For the C.A 6471 and C.A 6470N

- Dataview report generation software **P01102095**
- Adapter for recharging on vehicle cigarette lighter. **P01102036**
- Optical / RS communication cable **P01295252**
- GB mains power cable **P01295253**
- Set of 10 fuses - F 0.63 A - 250 V - 5x20 mm - 1.5 kA . . . **AT0094**
- Adapter for charging battery from the mains **P01102035**
- Battery pack **P01296021**
- Optical / USB communication cable. **HX0056-Z**

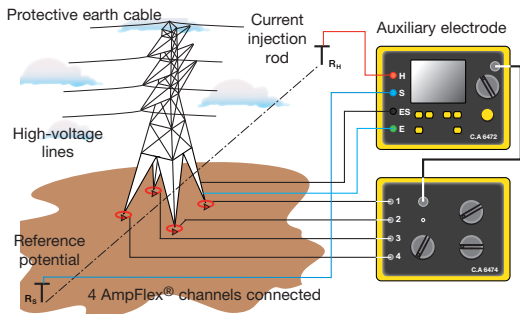

Earth and resistivity tester with adapter for pylon earth measurements

The C.A 6472 can be used to carry out a quick but comprehensive survey of all earthing configurations. When used with the C.A 6474 accessory, it allows users to measure the earth resistance of pylons.



	C.A 6472	Accessory C.A 6474
Reference	P01126504	P01126510
Specifications		
Measurements	Earth / Selective earth / Resistivity / Coupling / Continuity / Ground potential / Pylon earth (with C.A 6474)	Overall pylon earth Earth resistance of each pylon footing Overall line impedance Quality of the protective earth cable connection
Type	Methods: 3P / 4P / 4P with clamp / 2 clamps	Active measurement (injection by C.A 6472) Passive measurement (use of disturbance currents)
Measurement range	0.001 to 100 kΩ (automatic ranging)	
No-load voltage	16 V or 32 V (as required)	
Frequency	41 Hz to 5078 Hz	
Frequency sweep	Yes	
Auxiliary rod resistance measurement	Yes: 0.01 Ω to 100 kΩ	
U disturbance		
Measurement	0,00 to 65,0 V	
Noise rejection	Yes	
Power supply	Rechargeable NiMH battery	Powered by the C.A 6472
Display	3 digital LCD screens	
Storage	512 storage locations	
Communication output	Optical / USB link	
Safety	IEC 61010 & IEC 61557	
Dimensions / weight	272 x 250 x 128 mm / 3.2 kg	272 x 250 x 128 mm / 2.3 kg

State at delivery

- **C.A 6472:** delivered with mains adapter + 2P mains plug for battery recharging on mains, data export software + optical / USB communication cable, 2 x C182 clamps, 2 safety leads, 5 operating manuals (one per language) on CD-ROM, 5 simplified operating manuals (one per language), 5 identification labels (one per language), 1 bag.
- **C.A 6474:** delivered with an accessories bag containing 1 connection cable, 6 BNC/BNC cables 15 m long, 4 flexible current sensors (AmpFlex®) 5 m long, 1 set of 12 identification rings for AmpFlex®, 2 cables (5 m green, 5 m black) with safety plugs on winder, 5 spade lug/Ø 4 mm banana plug adapters, 3 clamps, 1 calibration loop, 5 operating manuals and 5 specification labels, each in a different language.

Earth and Resistivity Kit (100m Kit)
see page 16



Accessories

C.A 6472

- MN82 clamp (diam. 20mm) (delivered with 1 x 2m cable for ES terminal connection) . . . P01120452
- C182 clamp (diam. 20mm) (delivered with 1 x 2m cable for ES terminal connection) . . . P01120333

For the C.A 6472 and C.A 6474 :

- C.A 6472 – C.A 6474 connection cable P01295271
- 15 m BNC / BNC cable P01295272
- 5 m AmpFlex® flexible current sensor for C.A 6474 P01120550

- Set of 12 AmpFlex® identification rings P01102045
- Set of 3 adjustable clamps P01102046
- 5 m green cable for C.A 6474 (E terminal connection) P01295291
- 5 m black cable for C.A 6474 (ES terminal connection) P01295292
- Spade lug/Ø 4 mm banana plug adapters P01102028
- Calibration loop P01295294
- AmpFlex® flexible current sensors:
other lengths available on request



Earth Clamps and Loop Testers

600 V
CAT IV

IP
40



	C.A 6416	C.A 6417
Reference	P01122015	P01122016
Specifications		
Loop ohmmeter 1,500-count display	Measurement ranges (Ω) / Resolution (Ω) / Accuracy	
	0.010 to 0.099 / 0.001 / ±1.5 % ±0.01	
	0.10 to 0.99 / 0.01 / ±1.5 % ±2 r	
	1.0 to 49.9 / 0.1 / ±1.5 % ±r	
	50.0 to 99.5 / 0.5 / ±2 % ±r	
	100 to 199 / 1 / ±3 % ±r	
	200 to 395 / 5 / ±5 % ±r	
	400 to 590 / 10 / ±10 % ±r	
Frequency	Measurement frequency: 2083 Hz / Transposition frequency: 50, 60, 128 or 2083 Hz	
	Measurement ranges (μH) / Resolution (μH) / Accuracy	
Loop inductance measurement	10 to 100 / 1 / ±5 % ±r	
	100 to 500 / 1 / ±3 % ±r	
Contact voltage	Measurement ranges (V) / Resolution (V)	
	0.1 to 4.9 / 0.1	
	5.0 to 49.5 / 0.5	
Ammeter Measurement ranges (A) / Resolution (A) / Accuracy 4,000-count display	Measurement ranges (A) / Resolution (A) / Accuracy	
	0.200 to 0.999 mA / 1 μA / ±2 % ±50 μA	
	1.000 to 2.990 mA - 3.00 to 9.99 mA / 10 μA / ±2 % ±50 μA	
	10.00 to 29.90 mA - 30.0 to 99.9 mA / 100 μA / ±2 % ±r	
	100.0 to 299.0 mA - 0.300 to 0.990 A / 1 mA / ±2 % ±r	
1.000 to 2.990 A - 3.00 to 39.99 A / 10 mA / ±2 % ±r		
Setup		
Modes	Standard or advanced	
Alarms	Configurable on Z, V and A	
Buzzer	Active	
HOLD	Manual or automatic PRE-HOLD	
Automatic power-off	Active / Inactive	
General specifications		
Display	152-segment OLED. Active area 48 x 39 mm	
Max. clamping diameter	Ø 35 mm	
Storage	300 time/date-stamped measurements	2,000 time/date-stamped measurements
	Bluetooth Class 2	
Communication		
Power supply	4 x 1.5 V LR6 (AA) alkaline batteries or 4 x Ni-MH batteries	
Battery life	1440 x 30-second measurements	
Calibration	Automatic at start-up	
Electrical safety	IEC 61010 600 V CAT IV	
Protection	IP40	
Dimensions	55 x 95 x 262 mm	
Weight	Approx. 935 g with batteries	

State at delivery

- **C.A 6416:** 1 clamp delivered in a hard case with 4 x 1.5 V batteries, 1 CD-Rom containing the operating manual in 5 languages
- **C.A 6417:** 1 clamp delivered in a hard case with 4 x 1.5 V batteries, 1 CD-Rom containing the operating manual in 5 languages and the GTT software with simplified driver

Accessories

- CL1 calibration loop P01122301
- DataView P01102095
- Bluetooth USB modem P01102112
- Hard case P01298080



Locate hidden cables

Locate hidden circuits!

Comprising a transmitter and a receiver, the LOCAT-N provides digital, visual and audio indication of the presence of cables or ducts so that you can follow them intuitively.

300 V
CAT III

Transmitter



Receiver

C.A 6681 LOCAT-N	
Reference	P01141626
C.A 6681E transmitter	
Screen	LCD screen with display of functions and bargraph
Output signal frequency	125 kHz
External voltage measurement range	12 to 600 V _{ACDC}
Functions	Digital coding of signals for easy signal identification, selection of transmission signal code, torch function
Power supply	9 V battery
Dimensions	190 x 89 x 42.5 mm
Weight	420 g with battery
Electrical safety	300 V CAT III
C.A 6681R receiver	
Screen	Backlit LCD with display of functions and bargraph, transmission code, receiver and transmitter battery-charge status
Detection Depth	
> Single-pole application	0 to 2 m
> Two-pole application	0 to 0,5 m
> Simple looping line	Up to 2.5 m
Identification of mains voltage	Approximately 0 to 0.4 m
Functions	Automatic shutdown, automatic or manual adjustment of reception sensitivity, torch function
Power supply	6 x 1.5 V AAA batteries
Dimensions	241.5 x 78 x 38.5 mm
Weight	360 g with batteries

State at delivery

- **C.A 6681 LOCAT-N:** delivered in a hard case with 1 set of red/black 4 mm isolated banana leads (straight male / elbowed male), 1 set of 2 crocodile clips, 1 stake for earthing, 1 x 9 V battery, 6 x 1.5 V AAA batteries, 1 measurement adapter for B22 socket (bayonet), 1 adapter for E14 socket (screw-in), 1 mains socket adapter and 1 operating manual in 5 languages.





ELECTRICAL TESTING AND SAFETY

Micro-ohmmeters

- > 4-wire measurement method
- > Test current up to 10 A
- > Resolution: 1 $\mu\Omega$



State at delivery

C.A 6240 and C.A 6250 delivered with:

Mains power lead / leads with Kelvin clamps / software / optical / USB communication cable / bag



	C.A 6240	C.A 6250
<i>Low-level resistance measurements</i>		
Reference	P01143200	P01143201
Measurement method	4-wire method	
Resistance	400 $\mu\Omega$ to 400.0 Ω	1 $\mu\Omega$ to 2,500 Ω
Resolution	1 $\mu\Omega$	0.1 $\mu\Omega$
Accuracy	0.25 %	0.05 %
Current	10 mA to 10 A	1 mA to 10 A
Current inversion	Yes	No, but automatic compensation of eddy currents
Measurement mode	Inductive, non-inductive, non-inductive with automatic triggering	
Temperature compensation	no	Manual or with Pt 100 probe
Power supply	NiMH rechargeable battery	
Electrical safety	IEC 61010-1 / Cat III 50 V	
Dimensions	270 x 250 x 180 mm	
Weight	4.5 kg	4 kg



- > Permanent test at 100 A and up to 120 s at 200 A
- > Test current up to 200 A
- > Resistance measurements from 0.1 $\mu\Omega$ to 1 Ω
- > Safe measurements: Both Sides Grounded (BSG) method
- > Storage of up to 8,000 measurement results



	C.A 6292		
Reference	P01143300		
Test current	Programmable from 20 to 200 A		
Resistance	0.1 $\mu\Omega$ to 2 m Ω	2 to 200 m Ω	200 m Ω to 1 Ω
Resolution	0.1 $\mu\Omega$ (200 A max)	10 $\mu\Omega$ (25 A max à 200 m Ω)	1 m Ω (5 A max à 1 Ω)
Output voltage	100 VAC: 4.2 V @ 200 A / 220 VAC: 8.6 V @ 200 A		
Maximum load resistance	100 VAC: 20 m Ω @ 200 A / 220 VAC: 42 m Ω @ 200 A		
Measurement method	4 Kelvin-type connection terminals		
Test mode	Normal or BSG (Both Sides Grounded)		
Test duration	Adjustable from 5 to 120 s @200 A / unlimited below 100 A		
Storage	Up to 8,000 measurement results		
Interface	USB 2.0		
Software	DataView®		
Power supply	100 to 240 VAC – 50/60 Hz		
Dimensions	502 x 394 x 190 mm		
Weight	13 kg approx.		
Storage temperature	-10 °C to +70 °C		
Humidity	95% RH		
Protection	Protected against voltage surges, short-circuits, overheating and overvoltages on the output terminals		
Ingress protection	IP54		
Electrical safety	IEC 61010-1		

Current measurement with the optional MR6292 clamp

	MR6292
Reference	P01120470
Measurement range	1.0 - 50.0 ADC
Resolution	0.1 mA
Intrinsic uncertainty	\pm (1.5% + 2 cts)
Output signal	10 mV / Adc
Load impedance	>100 k Ω // 100 pF
Influence of conductor position in jaws	0.50 %

State at delivery

C.A 6292 delivered with:

a case containing: 1 set of 2 Kelvin leads 6 m long (red/black) with adjustable-clamp connections, 1 green earth lead 3 m long with 1 crocodile clip, 1 USB cable 1.5 m long, 1 fuse T 15 A 250V mounted in the instrument, 1 European mains lead, 1 user manual in 5 languages on CD-ROM, 1 CD-ROM containing the DataView software.

Accessories / Replacement parts

- 1 set of 2 Kelvin leads 15 m long (red/black) with adjustable-clamp connections P01295487
- 1 MR6292 current clamp for C.A 6292 P01120470
- 1 set of 2 Kelvin leads 6 m long (red/black) with adjustable-clamp connections P01295486
- 1 green earth cable with crocodile clip P01295488
- 1 set of 5 fuses: T 15A 250V 5x20 mm P01297101
- 1 USB-A USB-B cable 1.5 m long P01295293



Ratiometer

- > Transformation ratio measurement on power, voltage and current transformers
- > Storage of up to 10,000 measurement results

50V
CAT III

IP
53



DTR 8510

Digital ratiometer for transformers

Reference	P01143200	
Range of ratios (VT)	Automatic: 0.8000 to 8,000:1	
Accuracy (VT)	Range of ratios	Accuracy (% of reading)
	0.8000 to 9.9999	± 0.2 %
	10.000 to 999.99	± 0.1 %
	1000.0 to 4999.9	± 0.2 %
	5000.0 to 8000.0	± 0.25 %
Range of ratios (TC)	Autoranging: 0.8000 to 1000.0	
Accuracy (TC)	± 0.5 % of reading	
Excitation signal	VT mode: 32 Vrms max CT mode: Auto level 0 to 1 A, 0.1 to 4.5 Vrms	
Excitation current display	Range: 0 to 1,000 mA; Accuracy: ± (2 % R + 2 mA)	
Excitation frequency	70 Hz	
Display	Alphanumeric LCD, 2 lines of 16 characters with adjustment of contrast and backlighting. Easy to read in both daytime and nighttime conditions	
Available languages	French, English, Spanish, Italian, German, Portuguese	
Measurement method	According to IEEE Std C57, 12.90™ -2006 standard	
Power supply	Two rechargeable batteries: 12 V, NiMH, 1650 mAh	
Battery life	Up to 10 hrs in continuous operation, low-battery warning	
Battery charger	Universal input (90 to 264 Vrms), smart charger	
Charging time	< 4 hours for full charge	
Storage	10,000 tests	
Date / time	Power supplied by dedicated battery, real-time clock	
Communication	USB 2.0, optical isolation, 115.2 kB	
Software	Delivered with DataView® analytical software	
Dimensions / Weight	272 x 248 x 130 mm / 3.7 kg	
Connection	XLR connectors	
Leads	Screened H and X leads, length 4.6 m (15 ft), equipped with colour-coded crocodile clips	
Casing	Rugged polypropylene casing, UL 90 V0	
Vibrations	IEC 68-2-6 (1.5 mm at 55 Hz)	
Shocks	IEC 68-2-27 (30 G)	
Falls	IEC 68-2-32 (1 m)	
Protection rating	IP 40 with cover open as per EN 60529 IP 53 with cover closed as per EN 60529	
Safety	EN 61010-1, 50 V CAT IV, pollution degree 2	

State at delivery

DTR 8510 delivered with:

Delivered with a carrying bag containing 1 set of 4.6 m leads with crocodile clips, 1 external battery charger with mains power cable, 1 USB cable, 1 NiMH battery datasheet, 1 operating manual and DataView software on CD-Rom



POWER, ENERGY, DISTURBANCES

Energy analysers for three-phase networks

QUALI STAR+

- > 5 voltage inputs and 4 current inputs
- > 10-minute Inrush mode
- > Calculation of distorting power



1000 V
CAT III

600 V
CAT IV

3U
4I

4U
4I

IP
53

IEC
61000-4-30

EN
50160

IP
67



	C.A. 8331	C.A. 8333	C.A. 8336	C.A. 8435 AMP450 ⁽¹⁾
Reference	P01160511	P01160541	P01160591	P01160585
Number of channels		3U / 4I		4U / 4I
Number of inputs		4V / 3I		5V / 4I
IEC 61000-4-30			EN50160 reports	
Voltage (TRMS AC+DC)			2 V to 1,000 V	
Voltage ratio			Up to 500 kV	
Current (TRMS AC+DC)				
MN clamps		MN93 : 500 mA TO 200 A _{AC} ; MN93A : 0,005 A _{AC} TO 100 A _{AC}		
C193 clamp			1 A to 1 000 A _{AC}	
AmpFlex® or MA clamps		100 mA TO 10 000 A _{AC}		30 A TO 6 500 A _{AC}
PAC93 clamp			1 A TO 1 300 A _{AC/DC}	
E3N clamp			50 mA TO 100 A _{AC/DC}	
Current ratio			Up to 60 kA	
Frequency			40 Hz to 69 Hz	
Power values		W, VA, var, VAD, PF, DPF, cos φ, tan φ		
Energy values		Wh, varh, VAh, VADh		
Harmonics		Yes		
THD		Yes, orders 0 to 50, phase		
Expert mode			Yes	
Transients		50		210
Flicker (Pst and Plt)			Yes	
Inrush mode		Yes over 4 periods		Yes > 10 minutes
Unbalance			Yes	
Recording	Min/Max		Yes	
of a selection of parameters at max. sampling rate	4 hrs to 2 weeks	A few days to several weeks		2 weeks to several years
Alarm		4,000 of 10 different types		10,000 of 40 different types
Peak			Yes	
Vectorial representation		Automatic		
Display		TFT colour ¼ VGA screen, 320 x 240, diagonal 148 mm		
Capture of screens and curves	12			50
Electrical safety		IEC 61010 1 000 V CAT III / 600 V CAT IV		
Protection		IP53 / IK08		IP67
Languages		More than 27		
Battery life		Up to 13 hours		
Communication interface		USB		
Power supply		9.6 V NiMH rechargeable battery or mains power supply		
EN50160 report		Yes with DataView® software		
Dimensions		240 x 180 x 55 mm		270 x 250 x 180 mm
Weight		1.9 kg		3.7 kg
Warranty		3 years		

(1) with AmpFlex® 450 sensor

State at delivery

• **C.A. 8336 • C.A. 8333 • C.A. 8331** - Models without sensors: QualiStar+ analyser delivered with a bag for accessories, 5 x 4 mm banana voltage leads 3 m long, 5 crocodile clips, 12-colour identification kit for the leads and inputs, anti-scratch screen-protection film (mounted), USB cable, mains power cable, mains power pack, safety datasheet, 1 CD containing multi-language operating manual and 1 CD containing PC software for data recovery (Power Analyzer Transfer).

• **C.A. 8435 AMP450** : Delivered with bag no. 22, USB cable, IP67 mains power cable, 4 AmpFlex® 450 IP67 A196 current sensors, 5 x IP67 BB196 black banana leads, 5 lockable crocodile clips, 12-colour identification kit for the leads and inputs, anti-scratch screen-protection film (mounted), USB cable, mains power cable, mains power pack, safety datasheet, 1 CD containing multi-language operating manual and 1 CD containing PC software for data recovery (Power Analyzer Transfer).



Software

The measurements performed with the Qualistar models can be processed using two software products:

Power Analyzer Transfer (standard) and **DataView®** (option).

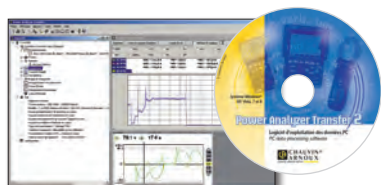

Power Analyzer Transfer

For transferring data onto a PC and communicating in real time via USB.

Supplied with the Qualistar+ models



DataView®

Powerful configuration, transfer and measurement data processing software, with generation of reports according to the voltage quality standards as well as **EN5010** reports (C.A 8333/8230)

DataView® is compatible with other Chauvin Arnoux® products:

- C.A 8220 & C.A 8230 power analysers
- F407 and F607 multimeter clamps
- and other measuring instruments

Minimum operating system required: Windows® 2000, Windows® XP, Windows® Vista, Windows® 7 and 8.

Reference	P01102095
-----------	-----------

Additional accessories

E3N adapter	P01102081
E3N mains power pack	P01120047
Battery pack	P01296024
Qualistar screen film	P01102059
Set of rings-inserts	P01102080
Set of 5 x IP67 banana leads 3 m long (BB196)	P01295479
Bag no. 21	P01298055
Bag no. 22	P01298056
USB-A USB-B cable	P01295293
5 A unit	P01101959
Lockable crocodile clips (x 5)	P01102099
Kit comprising banana leads (x 5), crocodile clips (x 5) and 1 set of coloured rings	P01295483
Kit comprising banana leads (x 4), crocodile clips (x 5) and 1 set of coloured rings	P01295476
Set of plugs (C.A 8435)	P01102147
Mains power pack (C.A 8335)	P01102057
IP67 mains power cable (C.A 8435)	P01295477

An accessory for all the Qualistar+ models



Essailec

A lead with an ESSAILEC plug can be used to perform tests without disturbing or interrupting the power supply circuit on meters and protection relays installed in the secondary circuits of current or voltage transformers. The main advantage is the speed and simplicity of measurement with maximum user safety.

Reference	P01102131
-----------	-----------

Stowing tool

Reeling Box for stowing your measurement leads.



Reference	P01102149
-----------	-----------

Clamps for Qualistar+



	MA193 -250	MA193 -350	MA196 -350	A193 -450	A193 -800	A196 -450	A196A -610
Reference	P01120580	P01120567	P01120568	P01120526B	P01120531B	P01120554	P01120554
Indice IP67	-	-	yes	-	-	yes	yes
Measurement range	100 mA to 10 kAac						
Clamping Ø / length	Ø 70 mm / 250 mm	Ø 100 mm / 350 mm	Ø 100 mm / 350 mm	Ø 140 mm / 450 mm	Ø 250 mm / 800 mm	Ø 140 mm / 450 mm	Ø 190 mm / 610 mm
IEC 61010	1 000 V CAT III / 600 V CAT IV						



	MN93	MN 93A	PAC93	C193	E3N	J93
Reference	P01120425B	P01120434B	P01120079B	P01120323B	P01120043A	P01120110
Measurement range	500 mA to 200 Aac	0,005 Aac to 100 Aac	1 A to 1 000 Aac 1 A to 1 300 Adc	1 A to 1 000 Aac	50 mA to 10 Aac/dc 100 mA to 100 Aac/dc	50 to 3 500 Aac 50 to 5 000 Adc
Clamping Ø	20 mm		1 x Ø 39 mm 2 x Ø 25 mm	52 mm	11,8 mm	72 mm
IEC 61010	600 V CAT III / 300 V CAT IV		600 V CAT III / 300 V CAT IV	600 V CAT IV	600 V CAT III / 300 V CAT IV	600 V CAT IV / 1 000 V CAT III



POWER, ENERGY, DISTURBANCES

Power and Energy Loggers

- > Single-phase, split-phase and three-phase installations
- > Installation without cutting off the mains power supply
- > Harmonic analysis up to the 50th order
- > Bluetooth, Ethernet and USB Communication
- > Automatic recognition of the sensors connected
- > Recording on SD card



	PEL102 (without current sensors)	PEL103 (without current sensors)
Reference	P01157152	P01157153
Display	Without	With triple digital display
Installation types	Single-phase, split-phase, three-phase with or without neutral, and many other specific configurations	
Number of channels	3 Voltage inputs / 3 Current inputs (neutral current calculated)	
Measurements		
Network frequency	DC, 50 Hz, 60 Hz & 400 Hz	
Voltage (Measurement ranges/ Best accuracy)	10.00 to 1000 V _{AC/DC} / +/- 0.2 % + 0.5 V	
Current (depending on sensors) (measurement ranges / best accuracy)	from 5 mA _{AC} to 10 kA _{AC} / 50 mA _{DC} to 1,4 kA _{DC} / ±0.5 %	
Calculated measurements		
Ratios	Up to 650,000 V / up to 25,000 A	
Power	10 W to 10 GW / 10 var to 10 Gvar / 10 VA to 10 GVA	
Energy	Up to 4 EWh / 4 EVAh / 4 Evarh (E = 1018)	
Phase	cos φ, tan φ, PF	
Harmonics	Up to 50th order	
Additional functions		
Phase order	Yes	
Min / Max	Yes	
Mounting	Magnet, hook	
Recording		
Sampling / Acquisition rate / Aggregation	128 samples/period - 1 measurement/s – from 1 min to 60 min	
Storage	SD Card, 8 GB (SD-HC Card up to 32 GB)	
Communication	Ethernet & Bluetooth	
Power supply	110 V - 250 V (+10 %, -15 %) @ 50-60 Hz & 400 Hz	
Safety	IEC 61010 600 V CAT IV – 1,000 V CAT III	
Mechanical specifications		
Dimensions	256 x 125 x 37 mm without sensor	
Weight	900 g	950 g
Casing	IP54 , ETL	

Accessories

DataVIEW® software	P01102095
Bag No 23	P01298078
Leads/clamps kit	P01295476
Set of id. rings/inserts	P01102080
5 A box	P01101959
PEL100 mains adapter	P01102134
MultiFIX	P01102100Z
Mains power cable	P01295174
Reeling Box	P01102149

State at delivery

- **PEL102** and **PEL103**: 4 measurement leads (straight banana / straight banana – 3 m long – black), 4 crocodile clips (black), 1 SD card (8 GB), 1 set of rings and inserts (for ends of leads and current sensors), 1 mains cable, 1 USB cable (Type A / Type B), 1 MultiFIX mounting systems, 1 operating manual (on CD), 1 bag, 1 safety datasheet, PEL Transfer PC software, 1 quick start-up guide, 1 SD MN adapter (depending on model).



PEL100 mains adapter
To self-power the PEL via the voltage measurement channel

Clamps for PEL



	MA193 -250	MA193 -350	MA196 -350	A193 -450	A193 -800	A196 -450	A196A -610
Reference	P01120580	P01120567	P01120568	P01120526B	P01120531B	P01120554	P01120554
Indice IP67	-	-	yes	-	-	yes	yes
Measurement range	100 mA to 10 kA _{AC}						
Clamping Ø / length	Ø 70 mm / 250 mm	Ø 100 mm / 350 mm	Ø 100 mm / 350 mm	Ø 140 mm / 450 mm	Ø 250 mm / 800 mm	Ø 140 mm / 450 mm	Ø 190 mm / 610 mm
IEC 61010	1 000 V CAT III / 600 V CAT IV						



	MN93	MN 93A	PAC93	C193	E3N	J93
Reference	P01120425B	P01120434B	P01120079B	P01120323B	P01120043A	P01120110
Measurement range	500 mA to 200 A _{AC}	0,005 A _{AC} to 100 A _{AC}	1 A to 1 000 A _{AC} 1 A to 1 300 A _{DC}	1 A to 1 000 A _{AC}	50 mA to 10 A _{AC/DC} 100 mA to 100 A _{AC/DC}	50 to 3 500 A _{AC} 50 to 5 000 A _{DC}
Clamping Ø	20 mm		1 x Ø 39 mm 2 x Ø 25 mm	52 mm	11,8 mm	72 mm
IEC 61010	600 V CAT III / 300 V CAT IV		600 V CAT III / 300 V CAT IV	600 V CAT IV	600 V CAT III / 300 V CAT IV	600 V CAT IV / 1 000 V CAT III

Power and energy logger

- > Ideal for mounting on electricity poles
- > All-terrain shockproof casing resistant to UV light and high temperatures
- > Self-powered by its voltage inputs up to 1,000 V
- > Continuous recording at 200 ms intervals
- > Measurements in compliance with IEEE 1459



PEL 105 P01157155	
Reference	
Display	With backlit triple digital display
Type of installation	Single-phase, split-phase, three-phase with or without neutral and many other specific configurations
Number of inputs	5 voltage inputs, 4 current inputs
Number of channels	4 voltage channels, 4 current channels
Measurements	
Network frequency	DC, 50 Hz, 60 Hz and 400 Hz
Voltage (measurement ranges / best accuracy)	10.00 V to 1,000 VAC @ 50/60 Hz, or 600 VAC @ 400 Hz / 1,000 VDC
Current (depending on sensors) (measurement ranges / best accuracy)	5 mAAC to 10 kAAC / 50 mADC to 1.4 kADC
Calculated measurements	
Ratio	Up to 650,000 V / up to 25,000 A
Power	20 W to 10 GW / 20 var to 10 Gvar / 20 VA to 10 GVA
Energy	Up to 4 EWh / 4 EVAh / 4 Evarh (E = 1018)
Phase	cos ϕ , tan ϕ , PF
Phase sequence	Automatic selection of the phase sequence
Harmonics	Up to the 50th order
Additional functions	
Phase sequence	Indication of valid connection
Min / Max	On all quantities
Recording	
Sampling rate/ Acquisition rate / Aggregation	128 samples/period - 5 measurements/s - from 1 min to 1 hr
Storage	SD card, 8 GB (up to 32 GB with SD-HC card)
Communication	Ethernet, Bluetooth, Wifi and USB
Power supply	Self-powered internally from 94 to 1,000 V @ 50-60 Hz & 400 Hz / DC
Safety	IEC 61010 1,000 V CAT IV
Mechanical specifications	
Dimensions	245 x 270 x 180 mm
Weight	< 4 kg
Protection	IP 67

Clamps for PEL

see page 24

State at delivery

PEL 105 delivered with:

- 5 x 3 m black silicone cables, straight banana / straight banana, 5 black 1,000 V CAT IV crocodile clips, 1 set of inserts/rings,
- 4 AmpFLEX® IP67 A196 3 m long, 1 set of waterproof plugs, 1 SD card, 1 USB cable, 1 bag, 1 safety datasheet, USB key containing 1 quick start-up guide and 1 user manual.

Reeling Box

for stowing the measurement leads of your PEL



Reference P01102149

Accessories

Clamps for PEL - see page 24

Set of waterproof plugs	P01102147
Pole-mounting kit	P01102146
DataView® software	P01102095
Crocodile clips kit (x 5)	P01102099
Set of inserts/rings	P01102080
5 A adapter	P01101959
Leads kit (x 5) BB196	P01295479
Reeling Box	P01102149
E3N adapter	P01102081
PA30 mains power pack	P01102057



PORTABLE OSCILLOSCOPES

Handheld oscilloscope with isolated channels

600 V
CAT III

IP
54



	OX 5022	OX 5042
Man-machine interface		
Type of display	3.5" colour TFT LCD screen – Resolution 320x240 – LED backlighting	
Display mode	2,500 real acquisition points on screen	
Display of curves on screen	2 curves + 2 references + memory trace or mathematical calculation	
Commands	Direct adjustments on front panel & on-screen menus via browser (principal & secondary without "hidden menus")	
Integrated interactive help function	11 languages: French, English, German, Spanish, Italian, Swedish, Romanian Rumanian, Russian, Finnish, Polish, Dutch	
Oscilloscope mode / Vertical deflection		
Bandwidth	20 MHz	40 MHz
Bandwidth limiter	1,5 MHz, 5 kHz	
Number of channels	2 totally-isolated channels	
Input impedance	1 MΩ ±0.5 %, approx. 17 pF	
Maximum input voltage	600 V CAT III – Derating -20dB per decade from 100 kHz	
Vertical sensitivity	5 mV to 200 V/div	
Horizontal deflection		
Sweep speed	25 ns/div to 200 s/div –Roll Mode from 100 ms to 200 s/div	
Horizontal zoom	Zoom factor: x1, x2, x5	
Triggering		
Mode	Automatic, triggered, one-shot & triggered Roll	
Type	Edge, pulse width (20 ns – 20 s)	
Coupling	AC or DC (depending on the coupling of the triggering channel), HF, LF or noise rejection	
Sensitivity	≤ 1.2 divisions p-p up to 20 MHz	≤ 1.2 divisions p-p up to 40 MHz
Digital memory		
Maximum sampling rate	Automatic, triggered, one-shot & triggered Roll	
Vertical resolution	9 bits	
Memory depth	2,500 points per channel	
User storage	2 MB for storing trace (.trc), text, (.txt), configuration (.cfg) and image files (.bmp)	
GLITCH mode	Duration ≥ 20 ns – 1,250 Min/Max pairs	
Display modes	Envelope, Averaging (factors 2 to 64) and XY (vector)	
Other functions		
MATH functions	Channel inversion, addition, subtraction, multiplication and division (adjustable scaling)	
Cursor measurements	2 cursors: V, T, dV, dt simultaneously –4-digit display resolution	
Automatic measurements	18 time or level measurements and phase measurement	
Multimeter mode		
General specifications	2 channels, 8,000-count display + min/max bargraph – Graphic recording of 2,700 measurements (5 min to 1 month)	
Operating modes	Absolute or relative display (absolute, deviation, ref, ref%) – Monitoring (instantaneous, Min, Max, Avg)	
AC, DC and AC+DC voltages	Ranges from 600 mV to 600 VRMS, 800 mV to 800 VDC – accuracy for VDC 1 %reading+20D –50 kHz bandwidth	
Resistance	Range from 80 Ω to 32 MΩ - accuracy 2%R + 10D –10 ms quick continuity test	
Capacitance	Ranges from 5 nF to 5 mF – basic accuracy 2 %reading+10D	
Other measurements	Frequency, rotation speed, 3.3 V diode test, temperature measurement (with K thermocouple or infrared probe)	
Power		
Measurements	Single-phase and balanced three-phase active power values (with or without neutral), simultaneous display of current	
Harmonic analyser mode		
Multi-channel analysis	2 channels, 31 orders, fundamental frequency from 40 to 450 Hz	
Simultaneous measurements	Total V _{RMS} , THD and selected order (%fundamental, phase, frequency, V _{RMS})	
General specifications		
Screenshots	Up to 100 files in standard ".bmp" format, viewable on the instrument	
PC communication	Isolated optical USB interface –"SX-Metro" PC application software available as an option (version CK)	
Power supply	6 LR6 or 6 AA NiMH batteries – Battery life up to 8 hrs 30 min – Universal mains adapter isolated from the channels – Quick charging in 2 hrs 30 min	
Safety / EMC	Safety according to IEC61010-1 Ed3 – 600 V CAT III – EMC according to EN61000-3, 2001 & EN61326-1, 2006	
Mechanical specifications	214x110x57mm – 1.2 kg with batteries – moulded elastomer casing, IP54 protection	
Warranty	3 years	

State at delivery

Version C: 1 oscilloscope delivered with 1 probe (1/10, 1000 V), 1 BNC/Banana adapter, 1 set of banana leads, 1 mains adapter, 1 set of 6 AA NiMH batteries, 1 "hands-free" bag, 1 CD-Rom containing 1 operating manual and 1 programming manual

Version CK: same as version C plus 1 optical USB communication cable and 1 CD containing the SX-METRO/P software and USB cable drivers

References

- OX5022-C:** 1 oscilloscope 2 x 20 MHz
- OX5022-CK:** 1 oscilloscope, 2 x 20 MHz + USB communication
- OX5042-C:** 1 oscilloscope 2 x 40 MHz
- OX5042-CK:** 1 oscilloscope 2 x 40 MHz + USB communication



On-site digital oscilloscopes

Scopix III 6 instruments in 1:

- > oscilloscope
- > FFT
- > multimeter
- > logger and harmonic analyser
- > wattmeter



	OX 7104	OX 7202	OX 7204
Quick selection			
Bandwidth	100 MHz	200 MHz	200 MHz
Number and type of channels	4 isolated channels	2 isolated channels	4 isolated channels
IEC 61010 safety		600 V CAT III	
Sampling rate per channel		2.5 GS/s in one-shot mode, 100 GS/s for periodic signals	
Transient detection		"Glitch" capture, minimum duration 2 ns	
Vertical resolution		12 bits, giving a vertical resolution of 0.025 %	
Display modes		Vector, interpolation, persistence, envelope, averaging (factors 2 to 64)	
Scaling and physical units		Definition of any factor and the corresponding unit	
Digital oscilloscope			
Input sensitivity		2.5 mV to 200 V/div (156 μ V max. with zoom thanks to the 12-bit resolution)	
Time base		1 ns to 200 s/div, Roll mode from 100 ms to 200 s/div	
Data storage		Several tens of thousands of 2,500-point curves (in universal "text" format) Memory depth up to 50 k – Mass storage on removable SD card up to 2 GB	
Reference curves on screen		1 per active channel (1 to 4) / Direct storage with dedicated key	
Automatic measurements with marker		20 simultaneous measurements on curves or deviations from the reference curve – 12-bit resolution	
Triggering		Edge, pulse width, delay, counting, video with line counter and on one of the 20 automatic measurements	
Calculation functions on channels		FFT on 2,048 points, +, -, x, /, and complex function generator	
TRMS multimeter (AC, AC+DC)			
Measurement channels with 200 kHz bandwidth	4 isolated channels	2 isolated channels	4 isolated channels
Measurement functions		Voltage, current, frequency, capacitance, temperature (Pt 100, K TC), diode test and audible continuity test, relative mode, min/max mode	
Graph of measurements with cursors		Duration from 5 min to 31 days, data storage in "universal text" format Triggering on threshold checks	
Harmonic analyser*			
Multi-channel analysis (2 or 4 depending on model)		61 orders, fundamental frequency from 40 Hz to 450 Hz	
Simultaneous measurements		Total V_{RMS} , THD and selected order (% fundamental, phase, frequency, V_{RMS})	
12-bit digital recorder*			
Multi-channel recording		Duration from 2 s to 31 days, normal mode or automatic fault capture mode with pre-trigger Sampling interval from 40 μ s (50 k memory)	
Recording conditions		On thresholds or windows, simultaneous conditions on several channels	
Analysis of recordings		Recording (50,000 points) on the PC hard disk or SD card	
Power measurement*		Scale and physical units, measurement by cursors, fault detection, zoom, etc.	
Measurement functions		Active, reactive and apparent power, on single-phase or three-phase, and PF	
Harmonics		Harmonic analysis on apparent power	
General specifications			
"Windows-like" operator interface		Colour	
Simultaneous display of traces		Up to 4 traces + 4 references on screen / "Full screen" trace mode	
PC communication and printing		RS232*, isolated USB* or Ethernet 10 Mb / Network or Centronics* printers FTP mode to use the PC hard disk as a storage unit Virtual Printer server LPD for printing on a printer connected to a PC Web server with real-time display, remote control and automatic measurements	
Power supply by rechargeable battery		Battery life up to 8 hrs, quick charging in 2 hrs without removing the batteries	
Warranty		3 years	

* Depends on model or option

Standard state at delivery

1 OX, 1 mains adapter/charger, 1 NiMH 9,6 V-3.8 A/h battery pack, 1 x 1/10 Probitx probe, 1 x \varnothing 4 mm banana - Probitx adapter, 1 set of \varnothing 4 mm banana leads, 1 Ethernet crossover cable, 1 USB cable, 1 μ SD-card with SD-card adapter, 1 magnetic stylus, 1 user manual and programming guide.

State at delivery of "CSDO" models

Same as "standard" plus 2 x 1/10 Probitx probes and Harmonics, Recorder and 50 kB options installed, SX-METRO-P software and hard case.

References

- OX7104-CSD** : oscilloscope 4 x 100 MHz
- OX7202-CSD** : oscilloscope 2 x 200 MHz
- OX7204-CSD** : oscilloscope 4 x 200 MHz
- OX7104-CSDO** : oscilloscope 4 x 100 MHz
- OX7204-CSDO** : oscilloscope 4 x 200 MHz





CURRENT MEASUREMENT

AC and AC/DC current measurement





Series	Model	Input ⁽¹⁾		Output / Connections			Specific features					To order								
		Very low current	Low current	Medium current	High current	~ AC	DC	Current	Voltage	Leads + safety plug ø 4 mm ⁽²⁾	Female sockets ø 4 mm		BNC connector (oscilloscope)	Transformation ratio (input/output)	Output protected against overvoltage	Automatic DC zero (low phase shift)	Power measurement	Bandwidth (frequency, in Hz)	Typical accuracy	
AC	 35 mm 115 mm 35 mm	MINI 01		2 to 150 A		●		0.15 A AC		●		1,000/1	●				48 Hz... 500 Hz	≤ 2.5 %	P01051101Z	
		MINI 02	50 mA to 100 A		●		0.15 A AC		●		1,000/1	●	●				48 Hz... 10 Hz	≤ 1 %	P01051102Z	
		MINI 03		1 to 100 A		●		0.1 V AC		●		1 A / 1 mV							≤ 2 %	P01051103Z
		MINI 05	5 mA to 10 A 1 to 100 A		●			10 V A AC 0.1 V AC		●		1 mA/1 mV 1 A/1 mV					48 Hz... 500 Hz	≤ 3 % ≤ 2 %	P01051105Z	
		MINI 09		1 to 150 A		●		15 V DC		●		1 A/100 mV							≤ 4 %	P01051109Z
	 18.5 mm 135 mm 51 mm	MN08		0.5 to 240 A		●		0.2 A AC		●		1,000/1					40 Hz... 10 kHz	≤ 1 %	P01120401	
		MN09		0.5 to 240 A		●		0.2 A AC		●		1,000/1					40 Hz... 10 kHz	≤ 1 %	P01120402	
		MN11		0.5 to 240 A		●		0.2 A AC		●		1,000/1	●				40 Hz... 10 kHz	≤ 2 %	P01120404	
		MN12		0.5 to 240 A		●		2 V AC		●		1A/10mV					40 Hz... 10 kHz	≤ 1 %	P01120405	
		MN13		0.5 to 240 A		●		2 V AC		●		1A/10mV					40 Hz... 10 kHz	≤ 1 %	P01120406	
		MN14		0.5 to 240 A		●		0.2 V AC		●		1A/1mV					40 Hz... 10 kHz	≤ 1 %	P01120416	
		MN39	0.1 to 24 A 0.5 to 240 A		●			2 V AC 2 V AC		●		1A/100mV 1A/10mV					40 Hz... 10 kHz	≤ 1 %	P01120408	
		MN73	10 mA to 2.4 A 100 mA to 240 A		●			2 V AC 2 V AC		●		1mA/1mV 1A/10mV					40 Hz... 10 kHz	≤ 1 % ≤ 2 %	P01120421	
	MN89		0.5 to 240 A		●		20 V DC ⁽³⁾		●		1A/100mV					40 Hz... 10 kHz	≤ 2 %	P01120415		
	 213 mm 20 mm	Y1N		4 A to 600 A		●		0.5 A AC		●		1,000/1	●				48 Hz... 1 kHz	≤ 3 %	P01120001A	
		 216 mm 31 mm 111 mm	C100		0.1 A to 1,200 A		●		1 A AC		●		1,000/1				30 Hz... 10 kHz	≤ 0.5 %	P01120301	
			C103		0.1 A to 1,200 A		●		1 A AC		●		1,000/1	●				30 Hz... 10 kHz	≤ 0.5 %	P01120303
			C122		1 A to 1,200 A		●		5 A AC		●		1,000/5	●				30 Hz... 10 kHz	≤ 1 %	P01120306
			C148	1 to 300 A 1 to 600 A 1 to 1,200 A		●		5 A AC		●		250/5 500/5 1,000/5	●				48 Hz... 1 kHz	≤ 2 % ≤ 1 % ≤ 1 %	P01120307	
C173			1 mA to 1.2 A 0.01 to 12 A 0.1 to 120 A 1 to 1,200 A		●			1 V AC		●		1A/1V 10A/1V 100A/1V 1,000A/1V				10 Hz... 3 kHz	≤ 0.7 % ≤ 0.5 % ≤ 0.3 % ≤ 0.2 %	P01120309		
 48 mm 310 mm		D30CN		1 to 3,600 A		●		1 A AC		●		3,000/1	●	●		30 Hz... 5 kHz	≤ 0.5 %	P01120064		
		D36N		1 to 3,600 A		●		3 A AC		●		3,000/3	●	●		30 Hz... 5 kHz	≤ 0.5 %	P01120055A		
AC/DC		 11 mm 15 mm 25 mm	K1	1 mA to 4.5 A DC 1 mA to 3 A RMS 1 mA to 4.5 A peak		●	●		4.5 V DC 3 V RMS 4.5 V peak		●		1mA/1mV				DC... 2 kHz	≤ 1 %	P01120067	
			K2	100 µA to 450 mA DC 100 µA to 300 mA RMS 100 µA to 450 A peak		●	●		4.5 V DC 3 V RMS 4.5 V peak		●		1mA/10mV				DC... 1.5 kHz	≤ 1 %	P01120074	
	 67 mm 231 mm 20 mm	E1N	0.05 to 2 A DC 0.05 to 1.5 A AC 0.5 to 150 A AC/DC		●	●		2 V DC 1.5 V AC 150 mV AC/DC		●		1A/1V 1A/1mV				DC... 2 kHz DC... 8 kHz	≤ 2 % ≤ 1.5 %	P01120030A		
		E6N	5 mA to 2 A DC 5 mA to 1.5 A AC 20 mA to 80 A AC/DC		●	●		2 V AC 1.5 V AC 0.8 V AC/DC		●		1A/1V 1A/10mV				DC... 2 kHz DC... 8 kHz	≤ 2 % ≤ 4 %	P01120040A		

(1) The higher value corresponds to 120% of the max. rated value
 (2) Reshaping of AC signal by diodes
 (3) Lead + electronic unit with Ø 4 mm safety plugs, 19 mm spacing, for K series

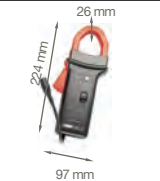

AC/DC current measurement



AC/DC	Series	Model	Input ⁽¹⁾						Output / Connections				Specific features				To order		
			Very low current	Low current	Medium current	High current	~ AC	DC	Current	Voltage	Leads + safety plug ø 4 mm ⁽²⁾	Female sockets ø 4 mm	BNC connector (oscilloscope)	Transformation ratio (input/output)	Output protected against overvoltage	Automatic DC zero		Bandwidth (frequency in Hz)	Typical accuracy
	 26 mm 224 mm 97 mm	PAC10	0.5 to 400 A AC 0.5 to 600 A DC					●	●			600 mV AC/DC	●		1A/1mV		DC... 5 kHz	≤ 2%	P01120070
		PAC11	0.2 to 40 A AC 0.4 to 60 A AC 0.5 to 400 A AC 0.5 to 600 A DC					●	●				600 mV AC/DC	●		1A/10mV 1A/1mV	●	DC... 10 kHz	≤ 1.5 % ≤ 2%
	 20 mm 224 mm 97 mm	PAC20	0.5 to 1,000 A AC 0.5 to 1,400 A DC					●	●			1.4 V AC/DC	●		1A/1mV		DC... 5 kHz	≤ 2%	P01120071
		PAC21	0.2 to 100 A AC 0.4 to 150 A DC 0.5 to 1,000 A AC 0.5 to 1,400 A DC					●	●				1.4 V AC/DC	●		1A/10mV 1A/1mV	●	DC... 10 kHz	≤ 1.5 % ≤ 2.5 %

(1) The higher value corresponds to 120% of the max. rated value (2) Lead + electronic housing with Ø 4 mm safety plugs, centre distance 19 mm, for K series.

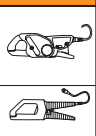
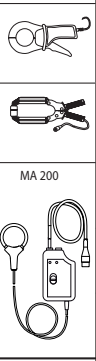
Measurement on oscilloscope

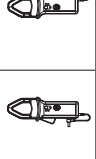
AC	Series	Model	Input						Output / Connections				Specific features				To order		
			Very low current	Low current	Medium current	High current	AC	DC	Current	Voltage	Lead + ø4 mm safety plugs ⁽²⁾	Female sockets ø 4 mm	BNC connector (coaxial)	Transformation ratio (input/output)	Output protected against overvoltages	Automatic DC zero		Power measurement (low phase shift)	Bandwidth (frequency in Hz)
AC		MN60	0.1 A to 60 A peak 0.5 A to 600 A peak						6 V peak	●		1 A / 100 mV 1 A / 10 mV					40Hz to 40kHz	≤ 2% ≤ 1.5%	P01120409
		Y7N	1 A to 1,200 A peak						1.2 V peak	●		1 mA / 1 mV					5Hz to 10kHz	≤ 2%	P01120075
		C160	0.1 A to 30 A peak 1 A to 300 A peak 1 A to 2,000 A peak						3 V peak 3 V peak 2 V peak			10 A/1 V 100 A/1 V 1,000 A/1 V					10Hz to 100kHz	≤ 3% ≤ 2% ≤ 1%	P01120308
		D38N	1 A to 90 A peak 1 A to 900 A peak 1 A to 9,000 A peak						0.9 V peak	●		1 A/10 V 1 A/1mV 1 A/0.1mV					30Hz to 50kHz	≤ 2%	P01120057A
		MA 200	MA200 30-300/3 (17 cm)	0.5 A...45 A peak 0.5 A...450 A peak						4.5 V peak	●		100 mV/A 10 mV/A					5 Hz... 1MHz phase shift at 1kHz ≤ 1.5	≤ 1% +0.3 A
MA200 30-300/3 (25 cm)	0.5 A...45 A peak 0.5 A...450 A peak							4.5 V peak	●		100 mV/A 10 mV/A					5 Hz... 1MHz phase shift at 1kHz ≤ 1.5	≤ 1% +0.3 A	P01120571	
	MA200 3000 /3 (35 cm)	5 A...4,500 A peak						4.5 V peak	●		1 mV/A					5 Hz... 1MHz phase shift at 1kHz ≤ 1.5	≤ 1% +0.3 A	P01120572	
AC/DC		E3N	0.05 A to 10 A peak 1 A to 100 A peak						1 V peak	●		1 A / 10 mV 1 A / 1 mV					DC to 100kHz	≤ 3% ≤ 4%	P01120043A
			PAC12	0.2 A to 60 A peak 0.4 A to 60 A DC 0.5 A to 600 A peak 0.5 A to 600 A DC						600 mV peak	●		1 A / 10 mV 1 A / 1 mV	●				DC to 10kHz	≤ 1.5% ≤ 2%
	PAC22		0.2 A to 150 A peak 0.4 A to 150 A DC 0.5 A to 1,400 A peak 0.5 A to 1,400 A DC						1.4 peak	●		1 A / 10 mV 1 A / 1 mV	●					DC to 10kHz	≤ 1.5% ≤ 2.5%

(1) The higher value corresponds to 120% of the max. rated value (2) Lead + electronic unit with ø 4 mm safety plugs with 19 mm spacing for the AmpFLEX series



CURRENT MEASUREMENT

AC current measurement

MA400D, MA 4000D

600 V
CAT IV

TRMS

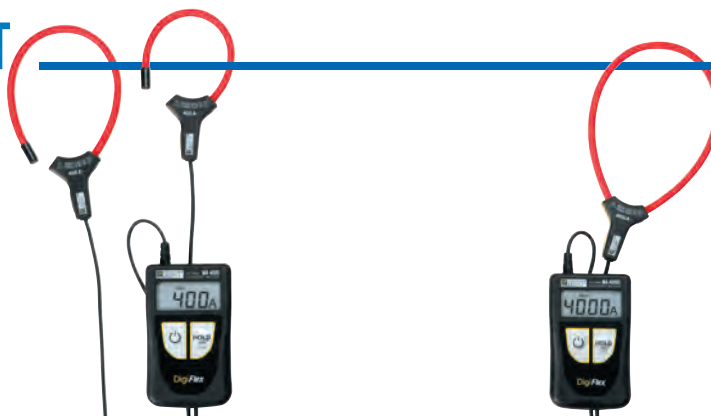

	MA400D-170 / MA400D-250			MA4000D-350		
References	P01120575Z / P01120567Z			P01120577Z		
Display range	4 A AC	40 A AC	400 A AC	40 A AC	400 A AC	4,000 A AC
Measurement range	0.020 A... 3.999 A	4.00 A... 39.99 A	40.0 A... 399.9 A	0.01 A... 39.99 A	40.0 A... 399.9 A	400 A... 3,999 A
Resolution	1 mA	10 mA	100 mA	10 mA	100 mA	1 A
Accuracy	± (2 % + 10 cts)	± (1.5 % + 2 cts)	± (1.5 % + 2 cts)	± (2 % + 10 cts)	± (1.5 % + 2 cts)	± (1.5 % + 2 cts)
Sensor clamping diam. / length	MA400D-170: Ø 45 mm / 170 mm MA400D-250: Ø 70 mm / 250 mm			MA4000D-350: Ø 100 mm / 350 mm		
Bandwidth	10 Hz ... 3 kHz					
Power supply	2 x 1.5 V AAA/LR3 batteries					
Safety	IEC 61010 CAT IV 600V					
Operating temperature	0°C to +50°C					
Instrument weight	Approx. 130 g					
Casing dimensions	100 x 60 x 20 mm					
Length of connection cable	0.8 m					

State at Delivery

1 DigiFLEX sensor delivered in a blister pack with 2 x 1.5V AAA batteries,
1 elastic strap and an operating manual in 5 languages

Accessories & Replacement Parts

Bag 120 x 200 x 60	P01298074
MULTIFIX accessories	P01102100Z
Elastic strap	P01102113

AmpFlex® flexible probes for AC current

1000 V
CAT IV

20 mA

30000 AAC

IP
67

4
calibres

A110,
A130



Series	Model	Input						Output - Connections				Specific features					Reference	
		Measurement range (1)						Current	Voltage	Lead + safety plugs ø 4 mm	Female sockets ø 4 mm	BNC connector (coaxial)	Transformation ratio (input/output)	Output protected against overvoltages	Automatic DC zero	Power measurement (low phase shift)		Bandwidth (frequency in Hz)
Very low current	Low current	Medium current	High current	Alternating current	Direct current													
A110	A110 3-30-300-3000/3 (45 cm / Ø 14 cm)	0.02 A - 3 A 0.5 A .. 30 A 0.5 A .. 300 A 0.5 A .. 3,000 A						3 VAC	(2)			1 V/A 100 mV/A 10 mV/A 1 mV/A				10 Hz .. 10 kHz 10 Hz .. 20 kHz 10 Hz .. 20 kHz 10 Hz .. 20 kHz	≤ 1%	P01120630
	A110 3-30-300-3000/3 (80 cm / Ø 25 cm)	0.02 A - 3 A 0.5 A .. 30 A 0.5 A .. 300 A 0.5 A .. 3,000 A					3 VAC	(2)			1 V/A 100 mV/A 10 mV/A 1 mV/A				10 Hz .. 10 kHz 10 Hz .. 20 kHz 10 Hz .. 20 kHz 10 Hz .. 20 kHz	≤ 1%	P01120631	
	A110 30-300-3000-30000/3 (120 cm / Ø 38 cm)	0.05 A - 30 A 0.5 A .. 300 A 0.5 A .. 3000 A 0.5 A .. 30,000 A					3 VAC	(2)			100 mV/A 10 mV/A 1 mV/A 0,1 mV/A				10 Hz .. 10 kHz 10 Hz .. 20 kHz 10 Hz .. 20 kHz 10 Hz .. 20 kHz	≤ 1%	P01120632	
A130	A130 30-300-3000/3 (80 cm / Ø 25 cm)	0.5 A .. 30 A 0.5 A .. 300 A 0.5 A .. 3,000 A					3 VAC				100 mV/A 10 mV/A 1 mV/A				10 Hz .. 20 kHz 10 Hz .. 20 kHz 10 Hz .. 20 kHz	≤ 1%	P01120633	

(1) The upper value corresponds to 120 % of the max. rated value. (2) Cable + electronic unit with Ø 4 mm safety plugs and 19 mm spacing.

MiniFlex® flexible probes for AC current

MA110, A130, MA200

600 V CAT IV	1000 V CAT III	20 mA	3000 A _{AC}	4 calibres	IP 67
-----------------	-------------------	-------	----------------------	---------------	----------



MA110 model

Measurement from 20 mA.
Can be connected to the AC voltage input (mVAC / VAC) of any multimeter or measuring instrument equipped with Ø 4 mm female banana plugs.

Three-phase MA130 model

Can be connected to the AC voltage inputs (mVAC / VAC) of any power analyser, logger or measuring instrument equipped with BNC plugs.

Three-phase MA200 model









Equipped with a BNC output and can be connected to all types of oscilloscopes. Offers high bandwidth.

Series	Model	Input				Output - Connections				Specific features				Reference		
		Measurement range (1)				Current	Voltage	Lead + safety plugs ø 4 mm	Female sockets ø 4 mm	BNC connector (coaxial)	Transformation ratio (input/output)	Output protected against overvoltages	Automatic DC zero		Power measurement (low phase shift)	Bandwidth (frequency in Hz)
Very low current	Low current	Medium current	High current	Alternating current	Direct current											
	MA110 3-30-300-3000/3 (17 cm / Ø 4,5 cm)	0.02 A - 3 A 0.5 A .. 30 A 0.5 A .. 300 A 0.5 A .. 3,000 A					3 VAC	(2)			1 V/A 100 mV/A 10 mV/A 1 mV/A			10 Hz .. 10 kHz 10 Hz .. 20 kHz 10 Hz .. 20 kHz 10 Hz .. 20 kHz	≤ 1%	P01120660
	MA110 3-30-300-3000/3 (25 cm / Ø 7 cm)	0.02 A - 3 A 0.5 A .. 30 A 0.5 A .. 300 A 0.5 A .. 3,000 A					3 VAC	(2)			1 V/A 100 mV/A 10 mV/A 1 mV/A			10 Hz .. 10 kHz 10 Hz .. 20 kHz 10 Hz .. 20 kHz 10 Hz .. 20 kHz	≤ 1%	P01120661
	MA110 3-30-300-3000/3 (35 cm / Ø 10 cm)	0.02 A - 3 A 0.5 A .. 30 A 0.5 A .. 300 A 0.5 A .. 3,000 A					3 VAC	(2)			1 V/A 100 mV/A 10 mV/A 1 mV/A			10 Hz .. 10 kHz 10 Hz .. 20 kHz 10 Hz .. 20 kHz 10 Hz .. 20 kHz	≤ 1%	P01120662
	MA130 30-300-3000/3 (25 cm / Ø 7 cm)		0.5 A .. 30 A 0.5 A .. 300 A 0.5 A .. 3,000 A				3 VAC				100 mV/A 10 mV/A 1 mV/A			10 Hz .. 20 kHz 10 Hz .. 20 kHz 10 Hz .. 20 kHz	≤ 1%	P01120663
	MA200 30-300/3 (17 cm / Ø 4,5 cm)		0.5 A...45 A _{CRÉTE} 0.5 A...450 A _{PEAK}				4,5 V _{PEAK}				100 mV/A 10 mV/A				≤ 1% + 0,3 A	P01120570
	MA200 30-300/3 (25 cm / Ø 7 cm)		0.5 A...45 A _{CRÉTE} 0.5 A...450 A _{PEAK}				4,5 V _{PEAK}				100 mV/A 10 mV/A			5 Hz...1 MHz	≤ 1% + 0,3 A	P01120571
	MA200 3000 /3 (35 cm / Ø 10 cm)		5 A...4,500 A _{PEAK}				4,5 V _{PEAK}				1 mV/A				≤ 1% + 0,3 A	P01120572







(1) The upper value corresponds to 120 % of the max. rated value. (2) Cable + electronic unit with Ø 4 mm safety plugs and 19 mm spacing.

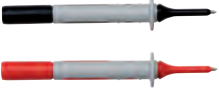

Banana connection accessories, Ø 4 mm

Model	Description	Moulded leads		Reference
		Specifications		
	Set of 2 red/black moulded PVC leads	Straight isolated male plug Ø 4 mm – Straight isolated male plug Ø 4 mm	<ul style="list-style-type: none"> • 15 A • 1.5 m • 1,000 V CAT IV 	P01295450Z
	Set of 2 red/black moulded PVC leads	Straight isolated male plug Ø 4 mm – Elbowed isolated male plug Ø 4 mm	<ul style="list-style-type: none"> • 15 A • 1.5 m • 1,000 V CAT IV 	P01295451Z
	Set of 2 red/black moulded Silicone leads	Straight isolated male plug Ø 4 mm – Straight isolated male plug Ø 4 mm	<ul style="list-style-type: none"> • 15 A • 1.5 m • 1,000 V CAT IV 	P01295452Z
	Set of 2 red/black moulded Silicone leads	Straight isolated male plug Ø 4 mm – Elbowed isolated male plug Ø 4 mm	<ul style="list-style-type: none"> • 15 A • 1.5 m • 1,000 V CAT IV 	P01295453Z
Standard leads				
	Set of 2 red/black PVC leads	Straight isolated male plug Ø 4 mm – Straight isolated male plug Ø 4 mm	<ul style="list-style-type: none"> • 15 A • 1.5 m • 600 V CAT IV / 1,000 V CAT III 	P01295288Z
	Set of 2 red/black PVC leads	Straight isolated male plug Ø 4 mm – Elbowed isolated male plug Ø 4 mm	<ul style="list-style-type: none"> • 15 A • 1.5 m • 600 V CAT IV / 1,000 V CAT III 	P01295289Z
	Set of 2 red/black PVC leads	Straight isolated male plug Ø 4 mm with rear connection – Straight isolated male plug Ø 4 mm with rear connection	<ul style="list-style-type: none"> • 20 A • 2 m • 600 V CAT III 	P01295290Z
Leads with built-in test probes				
	Set of 2 red/black PVC test-probe leads	Straight isolated male plug Ø 4 mm	<ul style="list-style-type: none"> • 15 A • 1.5 m • 1,000 V CAT IV 	P01295455Z
	Set of 2 red/black PVC test-probe leads	Elbowed isolated male plug Ø 4 mm	<ul style="list-style-type: none"> • 15 A • 1.5 m • 1,000 V CAT IV 	P01295456Z

Banana connection accessories, Ø 4 mm

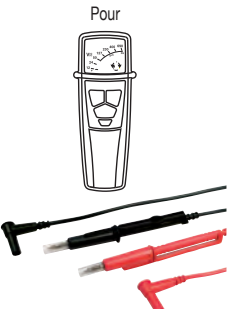
Pour installations CAT IV & CAT III				
Model	Description	Specifications		Reference
	Set of 2 red/black moulded test probes	Female plug Ø 4 mm	• CAT IV / CAT III 1,000 V	P01295454Z
For CAT II installation and below				
	Set of 2 moulded test probes Ø 4 mm	Female plug Ø 4 mm	• CAT II 300 V	P01295458Z
	Set of 2 moulded test probes Ø 2 mm	Female plug Ø 4 mm	• CAT II 300 V	P01295460Z
Magnetized measurement-probe leads				
	Set of 2 red/black magnetized test probes for voltage measurement only	Measurement probe Ø 6.6 mm, Elbowed female plug Ø 4 mm	CAT III 1,000 V / CAT IV 600 V	P01103058Z
IP2X				
	Set of 2 IP2X PVC leads for digital multimeters	Complies with NF C 18-510 and IEC 61010-031+A1:2008 IP2X test probe Elbowed isolated male plug	• 15 A • 1.5 m • 600 V CAT IV	P01295461Z
	Set of 2 IP2X PVC leads for voltage detectors	Complies with NF.C.18-510 and IEC 61010-031+A1:2008 IP2X test probe Ø 2 mm Elbowed female plug Ø 4 mm	• 15 A • 1.5 m • 600 V CAT IV	P01295463Z
	Set of 2 IP2X leads for voltage detectors	IP2X test probe Ø 4 mm Elbowed female plug Ø 4 mm	• 15 A • NF C 18-510 / IEC 61243-3 1,000 V	• 1.5 m: P01295462Z • 0.25 m & 0.85 m: P01295285Z



Protection, storage & transport

SHOULDER BAGS



S02

S03

BAGS



S20

S21

HARD CASES



M01

M04

M07

LEAKPROOF CASES



B01

B02

Photo	L x P x H	Référence
SHOULDER BAGS		
S02	120 x 245 x 60 mm	P01298075
S03	120 x 300 x 60 mm	P01298076
BAGS		
S20	330 x 240 x 240 mm	P01298078
S21	380 x 280 x 200 mm	P01298066
HARD CASES		
M01	270 x 195 x 65 mm	P01298071
M04	320 x 255 x 75 mm	P01298004
M07	440 x 310 x 135 mm	P01298072
LEAKPROOF CASES		
B01	272 x 248 x 130 mm	P01298068
B02	272 x 248 x 182 mm	P01298069

MOUNTING SUPPORT

With the compatible soft cases and shoulder bags, it can be used to transport and mount measuring instruments for more comfortable use.



MultiFix mounting accessory P01102100Z

REELING BOX

To avoid tangled cables. Can be used to store up 3 m of cable (1 x 3 m / 2 x 1,5 m). Built-in magnet for easy mounting on any metal surface.



P01102149



... by function

A

Accessories:	
• banana connections Ø 4 mm	p.32-33
• transport accessories (soft cases, hard cases, bags)	p.34
• protection accessories (soft cases, hard cases, bags)	p.34
• Essalec	p.23
Digital ammeters with flexible sensors	p.30
AmpFlex®	p.30
Reeling box	p.23/34
Electrical energy analysers for three-phase networks	p.22-23

C

Thermal camera	p.09
Flexible current sensors	p.29/31
Installation testers	p.11
Digital insulation testers	p.14-15
Insulation and continuity testers	p.12-13
Earth and resistivity testers	p.16
Earth and resistivity testers with adapter for pylon earth measurement	p.17

E

Power and energy loggers	p.24-25
--------------------------	---------

K

Earth and resistivity kit	p.16
---------------------------	------

L

Cable locator	p.19
DataView® software	p.14/23
Power Analyser software	p.23

M

Megohmmeters (see Insulation Testers)	
Micro-ohmmeters	p.20
Mini AC current clamps	p.28
TRMS digital multimeters	p.06-07
ASYC IV digital multimeters	p.08

O

On-site digital oscilloscopes	p.26/27
-------------------------------	---------

P

Clamps:	
• AC current	p.23/24/29
• AC/DC current	p.23/29
• digital multimeters	p.04/05
• earth and loop testers	p.23
AmpFlex® clamps	p.27

R

Ratiometer	p.21
------------	------

T

Tachometers	p.27
Testers	p.36

... by product

A

A110/130	Flexible current sensors	p.30
A193-450/A193-800	AmpFlex® clamps	p.23/24
Banana connection accessories Ø 4 mm		p. 32-33
Transport and protection accessories		p.34
AmpFlex®	Flexible current sensors	p.30

C

C100 to C173	AC current clamps	p.28-29
C193	AC current clamp	p.23/24
C.A 1725/1727	Tachometers	p.09
C.A 1950	Thermal camera	p.09
C.A 5271/5273/5275/5277	TRMS multimeters	p.07
C.A 6116N/6117	Installation testers	p.11
C.A 6240/6250	Micro-ohmmeters	p.20
C.A 6292	Micro-ohmmeters	p.20
C.A 6416/6417	Earth clamps and loop testers	p.18
C.A 6460/6462/6470N/6471	Earth and resistivity testers	p.16
C.A 6472/6474	Earth and resistivity testers with adapter for pylon earth measurements	p.17
C.A 6505	Digital insulation tester	p.19
C.A 6532/6534/6536	Insulation and continuity testers	p.12-13
C.A 6541/6543/6545/6547/6549	Digital insulation testers	p.14
C.A 6550/6555	Digital insulation testers	p.15
C.A 6681	Cable locator	p.19
C.A 745N	Tester	p.36
C.A 755/757	Testers	p.36
C.A 8331/8333/8336/8435	Electrical energy analysers for three-phase networks	p.22-23

D

DataView®	Software	p.14/23
D30CN / D36N	AC current clamps	p.32
D38N	AC current clamp	p.33
DTR 8510	Single-phase ratiometer	p.21

E

E1N/E6N	AC/DC Current clamps	p.28
E3N	AC/DC Current clamp	p.24/29
Essalec		p.28

F

F201/203/205	Digital multimeter clamps	p.04-05
F401/403/405/F407	Digital multimeter clamps	p.04-05
F601/603/605/F607	Digital multimeter clamps	p.04-05

J

J93	AC/DC Current clamp	p.22/24
-----	---------------------	---------

K

Earth and resistivity kit		p.16
K1/ K2	AC/DC current clamps	p.28

M

MA 100	Flexible current sensors	p.31
MA193	AC current clamps	p.23/24
MA 200	Flexible current sensors	p.29/31
MA400D/MA4000D	Flexible current sensors	p.30
MINI 01/02/03/05/09	Mini AC current clamps	p.28
MN60	AC current clamp	p.29
MN 08 to MN 89	AC current clamps	p.28
MN93/93A	AC current clamps	p.23/24
MTX 202/203	TRMS digital multimeters	p.06
MTX 3290/3291/3292/3293	Digital multimeters	p.08

O

OX 5022/5042	Digital oscilloscopes for use in the field	p.26
OX 7104/7202/7204	On-site digital oscilloscopes	p.27

P

PAC10/11/12	AC/DC current clamps	p.29
PAC20/21/22	AC/DC current clamps	p.29
PAC93	AC/DC current clamps	p.23
PEL 102/103/105	Power and energy loggers	p.24-25
Power Analyser	Software	p.23

R

Reeling Box	Stowing tool	p.23/34
-------------	--------------	---------

Y

Y1N	AC current clamp	p.28
Y7N	AC current clamp	p.29

TESTERS

Discover our new testers!



600 V
CAT III

IP
54

	C.A 745 N
Reference	P01191743Z
Voltage test	12 V to 690 V AC/DC (7 segments)
Audible beep	U > 50 V~
Impedance	400 kΩ
Phase/neutral identification	Flashing "Ph" diode and intermittent beep for U > 100 V AC
Operating frequency	DC and 50/60 Hz
Polarity test	"+" and "-" symbols
Voltage protection	up to 1,100 V
Audible continuity test	R < 2 kΩ
Resistance test	2 kΩ to 300 kΩ (3 diodes)
Standards	IEC 61010 600 V CAT III
Battery life	2 x 1.5 V batteries (LR03 or AAA)
Dimensions / weight	180 x 52 x 45 mm / 200 g

State at delivery

- **C.A 745 N** delivered in blister pack with 2 x 1.5 V LR03 batteries, 2 removable test probes (red/black)

Accessories and replacement for CA 745 N & C.A 755 / C.A 757

1 set of black/red CAT III/IV test probes.....	P01102152Z
1 set of black/red Ø 2 mm test probes, CAT II.....	P01102153Z
1 set of black/red Ø 4 mm test probes, CAT II.....	P01102154Z
C.A 753 adapter for 2P+E sockets.....	P01191748Z
Velcro strap x 5	P01102113
1.5 V LR3/AAA alkaline battery (x 1).....	P01296032
Bag compatible with MultiFix accessory, 120 x 200 x 60	P01298074
MultiFix mounting accessory	P01102100Z
MA101-250 current sensor for C.A 757	P01120591

600 V
CAT III

IP
54

	C.A 755	C.A 757
Reference	P01191755	P01191757
Current tests		
Measurement range via current sensor		500 mA to 300 A (2 calibres)
Resolution		0.01 A to 0.1 A
DC voltage		
Measurement range	3 mV to 1,000 V – 4 calibres	
Resolution	1 mV to 1 V	
AC voltage		
Measurement range	100 mV to 1,000 V – 4 calibres	
Resolution	1 mV to 1 V	
Operating frequency	DC and 50/60 Hz	
Impedance	10 MΩ	
No-contact voltage detection	With 230 V 50/60 Hz at a distance of approx. 5 cm	
Audible continuity test	R ≤ 30 Ω	
Resistance test		
Measurement range	0.3 Ω to 30 MΩ – 6 calibres	
Resolution	0.1 Ω to 0.01 MΩ	
Capacitance tests		
Measurement range	400 pF to 30 mF	
Resolution	0.001 nF to 0.01 mF	
Standards	600 V CAT III, IEC 61010-1, IEC 61010-031, IEC 61010-032, IEC 61010-033	
Power supply	2 x 1.5 V LR03 batteries	
Battery life	100 hours with alkaline batteries Automatic standby mode after 10 minutes	
Dimensions / weight	180 x 52 x 45 mm / 200 g	

State at delivery

- **C.A 755** delivered with 1 set of extra-fine test probes CAT III/CAT IV (red/black), 2 x 1.5 V AAA / LR3 alkaline batteries
- **C.A 757** delivered with 1 set of extra-fine test probes CAT III/CAT IV (red/black), 2 x 1.5 V AAA / LR3 alkaline batteries, 1 MiniFlex® sensor with a loop length of 250 mm, a connection cable 1 m long and a specific connector for C.A 757, 1 Velcro strap